

---

# **Johannesburg Stock Exchange**

## **Equity Market Trading and Information Solution**

### **JSE Specification Document**

### **Volume 00E – Trading and Information Overview**

<b>Version</b>	4.08
<b>Release Date</b>	11 March 2025
<b>Number of Pages</b>	114 (Including Cover Page)

---

# 1 DOCUMENT CONTROL

## 1.1 Table of Contents

<b>1</b>	<b>DOCUMENT CONTROL</b> .....	<b>2</b>
1.1	Table of Contents .....	2
1.2	Revision History .....	6
1.3	Contact Details .....	8
1.4	Definitions, Acronyms and Abbreviations .....	8
<b>2</b>	<b>OVERVIEW</b> .....	<b>14</b>
<b>3</b>	<b>OVERVIEW OF THE JSE TRADING MODEL</b> .....	<b>15</b>
<b>4</b>	<b>JSE MARKET STRUCTURE</b> .....	<b>16</b>
4.1	Market Definition .....	18
4.2	Market Segmentation .....	18
4.3	Instrument Definition .....	19
<b>5</b>	<b>JSE MARKET PARTICIPANT STRUCTURE</b> .....	<b>20</b>
5.1	Types of Users (Roles) .....	20
5.1.1	Traders .....	20
5.1.2	Interface users .....	21
5.1.3	Information Subscribers .....	21
<b>6</b>	<b>INSTRUMENT MANAGEMENT</b> .....	<b>22</b>
6.1	Unique Identification of Instruments .....	22
6.2	Exchange Market Size (EMS) .....	22
6.3	Minimum Reserve Size (MRS) .....	22
6.4	Minimum Execution Size (MES) .....	23
6.5	Futures Close-Out .....	23
6.6	Instrument Suspension .....	24
<b>7</b>	<b>SESSION MANAGEMENT</b> .....	<b>25</b>
7.1	Halt/Resume a session .....	25
7.2	Halt and Close session .....	25
7.3	Extend/Shorten sessions .....	25
<b>8</b>	<b>TRADING</b> .....	<b>26</b>
8.1	Types of Orders .....	26
8.1.1	Market Order (MO) .....	26
8.1.2	Limit Order (LO) .....	26
8.1.3	Pegged Hidden Orders .....	26
8.1.4	Pegged Hidden Limits Orders .....	27
8.1.5	Stop Order (SO) .....	28
8.1.6	Stop Limit Order (SL) .....	28
8.1.7	Central Order Book Cross .....	29
8.1.8	Iceberg Orders .....	30
8.2	Order Attributes .....	31
8.2.1	Order Capacity .....	35
8.2.2	Order Side .....	35
8.2.3	Time in Force Order Validity .....	35
8.3	Order Management .....	41
8.3.1	Cancellation .....	41
8.3.2	Amendment of Open Orders, Parked Orders and Hidden Orders .....	41
8.3.3	Client Account Amendment .....	41
8.3.4	Amendment of Unelected Orders .....	41
8.3.5	Own Order Book Download (OOBD) .....	42
8.4	Daily Life Cycle .....	42

8.4.1	Trading Sessions .....	43
8.4.2	Start of Trading Session .....	46
8.4.3	Opening Auction Call Session .....	46
8.4.4	Continuous Trading Session.....	47
8.4.5	Volatility Auction Call Session (triggered).....	48
8.4.6	Intraday Auction Call Session.....	49
8.4.7	Closing Auction Call Session (16:50* - 17:00*) .....	50
8.4.8	Closing Price Publication Session (*) .....	51
8.4.9	Closing Price Cross Session (*).....	52
8.4.11	Post Close Session.....	54
8.4.12	Trade Reporting Session (08:00 - 18:15) .....	55
8.4.13	Trade Reporting Halt Session (manually invoked) .....	55
8.4.14	Halt Session (manually invoked) .....	55
8.4.15	Halt and Close Session (with Closing Price) (manually invoked).....	55
8.4.16	Pause Session (manually invoked).....	56
8.4.17	Re-Opening Auction Call Session (manually invoked) .....	56
8.4.18	Futures Close Out Auction Call Session (12:00 - 12:15).....	57
8.5	Static and Dynamic Reference Price.....	60
8.5.1	Static Reference Price .....	60
8.5.2	Dynamic Reference Price .....	60
8.6	Order Book Matching Priority and Executions .....	60
8.6.1	Central Order Book .....	60
8.6.2	Volume Maximising Auction Algorithm .....	60
8.6.3	Auction Trading.....	62
8.6.4	Continuous Trading .....	64
8.6.5	Circuit Breakers .....	67
8.6.6	Self-Match Prevention .....	69
	Please refer to JSE Specification Document Volume 01E – Basic Native Trading Gateway and JSE Specification Document Volume 02 - Trading Gateway (FIX 5.0 SP2) for more information on the unique key. Illustrative examples of SMP functionality is available in appendix J for clarity and understanding. ....	70
8.7	Opening Price.....	70
8.8	Closing Price .....	70
8.8.1	Closing Price Definitions.....	70
8.8.2	Closing Price Methodology .....	71
8.8.3	General Closing Price Information.....	73
<b>9</b>	<b>REGULATORY NEWS SERVICE FOR JSE (SENS) AND NSX (NENS) .....</b>	<b>75</b>
<b>10</b>	<b>TRADE REPORTING (OFF-BOOK TRADES) .....</b>	<b>76</b>
10.1	Single Party Trade Reporting .....	76
10.2	Dual Party Trade Reporting.....	78
10.3	Validations .....	81
10.4	Trade Cancellations and Modification of Reported Trades .....	82
10.4.1	Same day Off Book Trade Cancellations by Firms – Single Party .....	82
10.4.2	Same day Off Book Trade Cancellations by Firms – Dual Party.....	84
10.4.3	Next day Off Book Trade Cancellations by Firms – Single Party .....	84
10.4.4	Next day Off Book Trade Cancellations by Firms – Dual Party.....	86
10.4.5	Own Trades Book Download (OTBD) .....	88
10.5	Central Order Book (On- Book Trades) .....	88
10.5.1	Next day Onbook Trade Cancellations by Firms – Single Party .....	88
10.5.2	Next day On Book Trade cancellation by Firms– Dual Party .....	89
<b>11</b>	<b>APPENDIX A – TRADE TYPES .....</b>	<b>93</b>
<b>12</b>	<b>APPENDIX B – VALID CORPORATE ACTION INDICATORS (EX MARKERS AND ANNOTATIONS) .....</b>	<b>95</b>
<b>13</b>	<b>APPENDIX C – TRADING LIQUIDITY PARAMETERS .....</b>	<b>96</b>
<b>14</b>	<b>APPENDIX D – PEGGED HIDDEN ORDER FUNCTIONALITY WORKED EXAMPLES....</b>	<b>97</b>
14.1.1	Example: Incoming Buy Visible order .....	97

---

	14.1.2	Example: Incoming Sell Visible order .....	97
14.2		Appendix E – Examples Of When Pegged Hidden Orders Will Be Deleted/Expired 98	
<b>15</b>		<b>APPENDIX F – EXAMPLES OF STOP AND STOP LIMIT ORDERS .....</b>	<b>100</b>
<b>16</b>		<b>APPENDIX G – SUMMARY OF FIX VS NATIVE VALUES FOR KEY FIELDS ON ORDERS AND TRADES .....</b>	<b>102</b>
<b>17</b>		<b>APPENDIX H – EOD VOLUME AUCTION WORKED .....</b>	<b>104</b>
<b>18</b>		<b>APPENDIX I – ICEBERG ORDERS WORKED EXAMPLES.....</b>	<b>106</b>
	18.1.1	Example: Passive Iceberg Order Execution and Replenishment.....	106
	18.1.2	Example: Aggressive Iceberg Order Execution.....	106
	18.1.3	Example: Pro-Rated Iceberg Hidden Quantity Policy.....	107
<b>19</b>		<b>APPENDIX J – SELF-MATCH PREVENTION WORKED EXAMPLES.....</b>	<b>108</b>
	19.1.1	Submission of an Order with a Unique Key via FIX / Native Trading Gateway Resulting in Self-Match Prevention .....	108
	19.1.2	Self-Match Prevention Functionality in Relation to Circuit Breakers .....	108
	19.1.3	Self-Match Prevention Functionality in Relation to Fill or Kill (FOK) Orders 110	
	19.1.4	Example: Self-Match Prevention Functionality in Relation to Closing Price Cross (CPX) Orders.....	112
	19.1.5	Example: Self-Match Prevention Functionality in Relation to Iceberg Orders .....	114

---

## Document Information

---

<b>Drafted By</b>	JSE
<b>Status</b>	Final
<b>Version</b>	4.08
<b>Release Date</b>	11 March 2025

## 1.2 Revision History

Date	Version	Description
09 December 2011	1.00	Initial Draft
22 March 2012	1.01	Updated Version
14 June 2012	1.02	Updated Version and renamed Volume version to 00
16 August 2012	1.03	Updated Version
12 September 2012	1.04	Updated Version
29 October 2012	1.05	Updated Version
22 November 2012	1.06	Updated Version
08 July 2013	2.00	Updated Version to include 2013 Product Upgrade functionality
06 August 2013	2.01	Updated Version to include CPP session time for all trading Segments
10 September 2013	2.02	Updated Version
November 2013	2.03	Updated Version
1 July 2014	2.04	Updated version to include new Circuit Breaker percentages
25 August 2014	2.05	Updated version to include Excluding Hidden Order attribute, not allowing Hidden Limit Orders during the CPX session and publishing rounded closing prices
07 January 2015	2.06	Updated section 8.4.8 for cancellation of orders in the main container during the Closing Price Publication session.
05 February 2016	2.07	Update to Dealing Capacity and Trade Reporting Model for Delta Trade (OD)
26 May 2016	3.00	Updated version to include ItaC Project 1a Changes for the Equity Market Upgrade and the Equity Market Enhancements
23 September	3.01	Updated version to include new Minimum Reserve Size (MRS) calculation Updated to extend Closing Price Cross Session to ZA11 and ZA12
08 March 2017	3.02	Updated the EMS Calculation Methodology
24 August 2018	3.03	8.6.5 Circuit Breaker table updated to include ZA06 8.8.2.3 Closing Price Methodology 3 updated to include Previous Close Trading Sessions and Order Validity Combinations updated
30 November 2018	3.04	8.6.5 Circuit Breaker percentages amended for Closing Auction for ZA01 and ZA02 8.6.3 Amended Random uncrossing time from 30s to 60s
05 March 2019	3.05	8.6.5 Circuit Breaker percentages amended for ZA01, ZA02 & ZA6 8.6.5 Circuit Breaker percentages added for ZA03 and ZA04 The number of extensions for the Price Monitoring Extension session reduced from 2 to 1

11 July 2019	3.06	8.4.1.1, 8.4.1.2, and 8.4.1.3 Trading Sessions amended for ZA06 8.8.2.3 Methodology 3 amended for ZA06 Appendix: A, B, H Updates, Update section 6.5
16 September 2019	3.07	8.1.8 Details about Iceberg Orders added Appendix 18: Examples of Iceberg Orders added Details of EHL Orders removed throughout
27 November 2019	3.08	8.4.7 Closing Auction Call Session Early Close Threshold duration has been configured to 6 minutes for both JSE and NSX markets
02 December 2019	4.00	Updates related to the 2020 Product Upgrade
19 October 2020	4.01	8.1.3 Update to Pegged Hidden Order configuration setup
18 May 2021	4.02	6.3 Update to MRS calculation details 8.4.1. Trading session update – removal of the EOD Volume Auction session details
13 August 2021	4.03	6.5, 8.4.1.3 Update to Futures Close Out 8.4.1, 8.4.11 Trading session updates
13 April 2022	4.04	8.4.1.2 Trading session updates Appendix A: Addition of Matched Principal Trade Type
<u>27 January 2023</u>	4.05	6.3 Updated Minimum Reserve Size logic for Hidden Pegged Orders 8.1.8 Iceberg Orders participating in Auctions fully detail added 8.4.3, 8.4.5, 8.4.6. 8.4.7, 8.4.17 and 8.4.18 updated with iceberg order and pegged hidden order logic. 8.6.5.2 Updated with more detail on auction times 8.4.7 Updated Early Close Threshold duration to 10min 8.6.2 updated wording 8.6.3.2 updated wording 8.4.8, 8.4.9 timing of sessions updated and wording changes; additional explanation of iceberg orders during CPX 8.8.1., 8.8.3 Clarity added to Closing Prices referencing a last traded price being an XT with a decimal value
<u>27 May 2024</u>	4.06	8.4, 8.6.6 Self-Match Prevention functionality added 8.8.2.2 Closing Price Methodology 2 updated Appendix J: Addition of Self-Match Prevention scenarios
<u>3 September 2024</u>	4.07	8.6.6 Updated Self-Match Prevention unique key details
<u>11 March 2025</u>	<u>4.08</u>	<u>1.4 Added a definition for Trading at Free-of-Value</u> <u>10.5 Added a section on Central Order Book (On-Book Trades).</u> <u>Included a description of next day on-book trade cancellation for both single-party and dual-party transactions.</u>

---

## 1.3 Contact Details

---

<b>JSE Limited</b> Trading and Market Services One Exchange Square Gwen Lane, Sandown South Africa Tel: +27 11 520 7000  <a href="http://www.jse.co.za">www.jse.co.za</a>	<b>Client Services Centre</b> Email: <a href="mailto:CustomerSupport@jse.co.za">CustomerSupport@jse.co.za</a> Tel: +27 11 520 7777
<p><b>Disclaimer:</b> All rights in this document vests in the JSE Limited ("JSE") and Millennium IT Software (Private) Limited ("Millennium IT"). Please note that this document contains confidential and sensitive information of the JSE and Millennium IT and as such should be treated as strictly confidential and proprietary and with the same degree of care with which you protect your own confidential information of like importance. This document must only be used by you for the purpose for which it is disclosed. Neither this document nor its contents may be disclosed to a third party, nor may it be copied, without the JSE's prior written consent. The JSE endeavours to ensure that the information in this document is correct and complete but do not, whether expressly, tacitly or implicitly, represent, warrant or in any way guarantee the accuracy or completeness of the information. The JSE, its officers and/or employees accept no liability for (or in respect of) any direct, indirect, incidental or consequential loss or damage of any kind or nature, howsoever arising, from the use of, or reliance on, this information.</p>	

## 1.4 Definitions, Acronyms and Abbreviations

<b>Automated Trades (AT)</b>	On Book trades executed automatically during whether an auction period or continuous trade.
<b>Uncrossing Trade (UT)</b>	Automated trade that results specifically from the uncrossing of the order book during an auction Trading period.
<b>Binary Trade Reporting</b>	A separate Trade Capture Report (TCR) generated for each side of a trade on every trade.
<b>Business Day</b>	Any day except a Saturday, Sunday, public holiday or any other day on which the JSE is closed.
<b>Central order book</b>	The order book of the JSE equities trading system in which automated and auction trades occur.
<b>Circuit Breaker (CB)</b>	A Circuit Breaker prevents unnatural price movements in an instrument by triggering a Volatility Auction Call session.
<b>Circuit Breaker Tolerance</b>	Defines the maximum allowed change (via a percentage) of the next possible trade's price from the Static or Dynamic Reference Price.
<b>Client</b>	Has the same meaning as that contained in section 1 of the Act.
<b>Closing Price Cross (CPX) session</b>	A dedicated session after the closing price of an instrument has been determined allowing extended trading only at the instruments closing price.



<b>Closing Price Publication (CPP) session</b>	The session immediately preceding the CPX session in which the closing price of the instrument is published to the market.
<b>Confirmed Off Book Trade</b>	In the case of a two member Off Book trade, where both TSPs have submitted electronic messages to indicate their agreement and acknowledgement of the trade by the equities trading system.
<b>Continuous Trading session</b>	Defines the session where the orders are continuously executed on a price-visibility-time priority.
<b>Default User</b>	The User within the member firm with the privilege to submit/cancel Off Book Trades. If no Default User has been specified, the member will not be able to submit or receive Off Book Trades.
<b>Elected order</b>	A Stop or Stop Limit order moved into the central order book once the trigger price is met.
<b>Equity securities</b>	Those JSE listed securities traded on the JSE equities trading system.
<b>Exchange Market Size (EMS)</b>	A quantity of an equity security as specified by the Market Controller from time to time;
<b><u>Trading at Free-of-Value</u></b>	<p><u>Free of value trading typically refers to transactions where securities are transferred without a corresponding payment. This can occur in various scenarios, such as internal transfers within a brokerage, corporate actions, or settlement adjustments.</u></p> <p><u>Trading at Free-of-Value basically means a transaction is being reported to the JSE with a price and volume, but this is instructed to settle outside of the system and does not result in any cash movements. This is achieved by stipulating a different Settlement Currency.</u></p>
<b>Hidden Limit Order</b>	Identifies an order that is not visible to the market. The order quantity is greater than or equal to Minimum Reserve Size (MRS), has a visible size equal to zero and must have a Minimum Execution Size (MES).
<b>Iceberg Order</b>	Identifies an order that is partially visible to the market. A disclosed quantity is specified in addition to the order quantity. The total order quantity consists of two quantity components; visible and hidden.
<b>Incoming Order</b>	An order that is walking through the order book and seeking executions.
<b>Indicative Auction Information</b>	<p>During an auction prior to the uncrossing, the below mentioned indicative auction information will be disseminated:</p> <p>(a) Indicative Auction Price</p> <p>Executable volume at the Indicative Auction Price.</p>

---

<b>Indicative Auction Price (IAP)</b>	(b) The indicative auction uncrossing price calculated throughout the auction using the Volume Maximising Auction Algorithm (relevant to each auction) applied to orders for an instrument. If the system cannot determine an auction uncrossing price, no IAP will be published.
<b>Indicative Auction Volume</b>	The volume that is tradable at the Indicative Auction Price using the Volume Maximising Auction Algorithm.
<b>Injected order</b>	A parked order moved into the central order book once its “Time in Force” condition is met.
<b>Instrument</b>	A unique tradable entity. All trading takes place at an Instrument level.
<b>Inter-day</b>	This period will fall out of the normal trading period
<b>Intra-day</b>	This period will fall within the normal trading periods of the markets.
<b>ISIN</b>	International Securities Identification Number
<b>JSE</b>	Johannesburg Stock Exchange
<b>Limit order</b>	An order where the number of shares and price is specified.
<b>Lot Size</b>	This is the minimum order size for an instrument always defined as 1.
<b>Market End</b>	The End of Market is published through the Market Data Gateways. Any remaining orders that are only valid for the current day will be expired during this period.
<b>Market Announcements</b>	<b>Operations</b> Exchange announcements disseminated to trading participants. An announcement can relate to the market in general (e.g. market-wide halt) or to a particular instrument (e.g. suspension)
<b>Market Order</b>	Is an order where no limit price is specified and only the volume of shares to be executed is specified on the order. A Market Order will execute against as many orders on the opposite side of the order book as are necessary to fill the order.
<b>Market Order Extension</b>	A Market Order Extension to an auction call session will be triggered if there are Market Orders within the order book that are not executable or only partially executable (i.e. there is a market order surplus) at the end of the auction call session.
<b>Market Start</b>	Instruments that are available for trading are published through the Market Data gateways. Any orders due to expire will be expired during this period.

---

<b>Market Users</b>	Defines the Traders and Interface users (including Information Subscribers) created in the System.
<b>Maximum Quantity</b>	Also known as Maximum Order Size. Defines the Maximum allowed quantity of an order.
<b>Minimum Execution Size (MES)</b>	Minimum Execution Size is the minimum volume of the Hidden Limit order which is permitted to execute.
<b>Minimum Reserve Size (MRS)</b>	Minimum Reserve Size (is the equivalent of the JSE's MOS – for Hidden Limit orders) MRS is the minimum order volume for orders to qualify as Hidden Limit orders. All Hidden Limit orders are validated against this parameter.
<b>NENS</b>	Stock Exchange New Service of the NSX
<b>NSX</b>	Namibian Stock Exchange
<b>Off Book Trade</b>	A trade negotiated outside the System yet reported to the System, in accordance with the JSE Rules and Directives.
<b>On Book Trade</b>	An Automatic Trade which is a trade automatically executed in the System which can either be an Automated Trade or an Uncrossing Trade.
<b>Open Order</b>	Identifies an order which has a remaining quantity in the order book. An amendment or a cancellation can be done for an Open Order.
<b>Order Execution Report (OER)</b>	An Order Execution Report is the acknowledgement by the system of either the acceptance or rejection of a new order or an order amendment.
<b>Order Quantity</b>	The quantity being bought or sold. This should be a whole number that is greater than zero and must be a multiple of the instrument's Lot Size.
<b>Overall BBO</b>	Best bid and offer out of all Hidden Limit and Visible Orders.
<b>Parked Order</b>	An order submitted by a Participant will be held in the system until the applicable period is reached, at which point it is passed onto the order book. GFA, GFX, ATC and CPX orders will be parked until the relevant auction call phase is started. Unelected Stop and Stop Limit orders will be parked until the stop price is reached.
<b>Participant</b>	Participant refers to a Member Firm that is registered with the JSE to trade or an Information Subscriber
<b>Passive Order</b>	An order residing in the order book.
<b>Post Trade Interface User</b>	An interface user with the relevant privileges to login and manage trades through the Post Trade Gateway

---

<b>Price Improvement</b>	The logic applied to the execution price when Pegged Hidden and Pegged Hidden Limit Orders execute within the order book to ensure fair execution pricing.
<b>Price Monitoring Extension</b>	A Price Monitoring Extension to an auction call session will be triggered if the likely auction uncrossing price of an auction call session will breach the defined circuit breaker tolerances. If trades cannot be executed during the uncrossing, it is not possible to have a price monitoring extension.
<b>Published</b>	In relation to an Off Book trade, the disclosure by the JSE of the price and quantity of equity securities traded.
<b>Random Replenishment Percentage</b>	Determines the lower limit of the random replenishment quantity based on the initially indicated visible quantity of the Iceberg Order.
<b>Reference Price</b>	The last auction or automated trade price or the previous closing price, whichever is the most recent, or in the absence of a last auction or automated trade price or a previous closing price, a price as determined by the JSE.
<b>SENS</b>	Stock Exchange News Service of the JSE
<b>Single Transaction</b>	Defines the life cycle of a single aggression of the order; there may be multiple executions the order may receive during a single transaction.
<b>Start of Day</b>	The period where the System processes are started up.
<b>Stop Limit Order</b>	A Limit Order that will remain unelected (without entering the order book) until the stop price is reached. Once elected, a Stop Limit Order will be treated similar to a regular new Limit Order.
<b>Stop Order</b>	A market order that will remain unelected (without entering the order book) until the stop price is reached. Once elected, a Stop Order will be treated similar to a regular Market Order.
<b>Tick Size</b>	The minimum possible price/price increment which can be used for an order. This is set to 1 for the JSE and NSX markets.
<b>Time in Force</b>	A special instruction used when placing an order to indicate how long an order will remain active before it is executed, expired or deleted.
<b>Trade cancellation</b>	The cancellation of an On Book or Off Book trade on the same business day or the next business day.
<b>Trading Cycle</b>	A Trading Cycle defines a list of trading sessions for a trading day.

---

<b>Trading Services Provider (TSP)</b>	A member which has been authorized by the JSE to perform trading services in terms of the rules.
<b>Trading Session</b>	Defines a set of trading rules during a particular phase of a trading day.
<b>Trader</b>	An entity created in the system with privileges to manage orders/trades. Also known as User.
<b>Trader Group</b>	The group with the trader belongs to. Also known as Node.
<b>Trade Capture Report (TCR)</b>	Trade Capture Reports are generated messages which provide details of On or Off Book trades as separate messages (i.e. for a trade there will be two separate trade captures, each corresponding to one side of the trade).
<b>Unmarketable Order</b>	An order which cannot be further executed with the available liquidity on the contra side of the order book.
<b>Visible BBO</b>	Best visible Bid and Offer which consists of the best bid of all Visible Orders and the best offer of all Visible Orders.
<b>Visible Order</b>	Identifies an order that is visible to the market. The order has a Visible Size that is equal to Order Quantity.
<b>Volatility Auction Call Session</b>	Defines the session where a security is automatically moved to after a circuit breaker has been triggered.
<b>Pegged Order</b>	A hidden order pegged to the mid-point of the best bid and offer price or pegged to the best bid(offer) for instrument
<b>Pegged Limit Order</b>	A pegged order with a stop price also known as a hard limit.
<b>Centra Order Book Cross Trade (XT)</b>	A trade resulting from the submission of a Cross Order by market participants that results only in a trade and has no impact to orders.
<b>EOD Volume Auction Call (VT)</b>	A dark auction that is triggered after the CPX session where orders are time ranked meant for large executions at the Closing Price.

## 2 OVERVIEW

The purpose of this document is to provide an overview of the Equity Market Trading and Information Solution available to market users. The scope of this document will be the trading system and will provide a detailed description of the trading system functionality supporting the JSE's Equity Market Model. There are various other information services provided for by the Equity Market Trading and Information System (Drop Copy, Market Data and JSE Downstream services) but these will be covered separately and are excluded from the scope of this document.

For the purpose of trading, two access points are provided for market users namely:

- The Equity Trading Gateway (either Native or FIX) that allows for interactive trading
- The Post Trade Gateway for processing and publishing of On and Off Book trades, binary trade reporting and trade management (cancellations of On and Off Book trades) by market users.

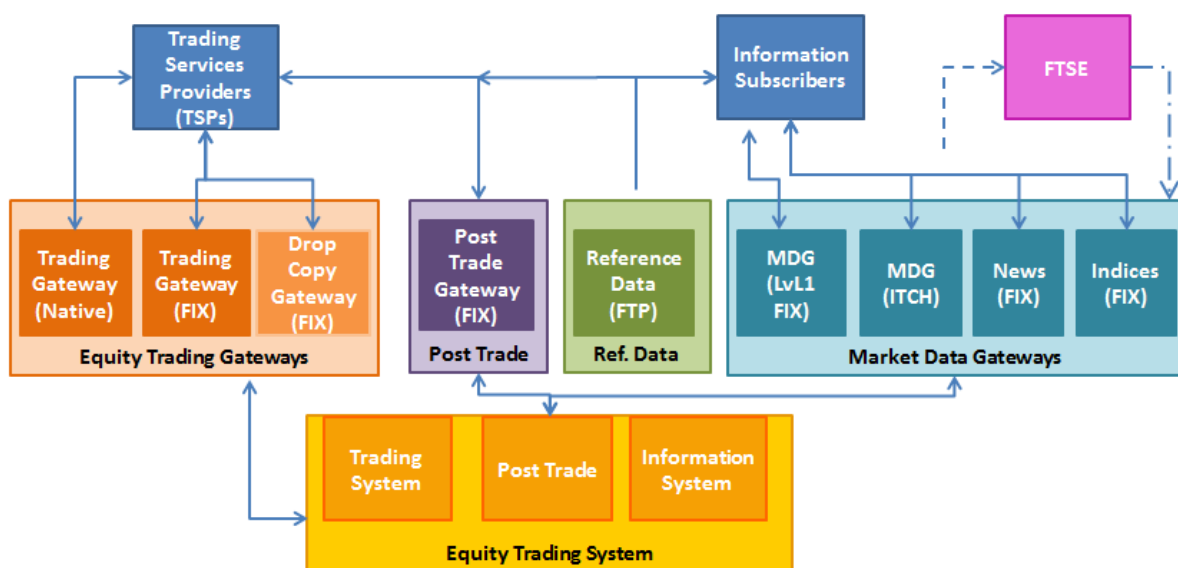

Market Operations functionality, which is also provided for in the Trading Gateway, is included in this document for reference and information. This refers to functions and processes used by the JSE Market Operations team to ensure that the market operates in accordance with market expectations.

---

### 3 OVERVIEW OF THE JSE TRADING MODEL

The trading model applied is based on core order-driven trading functionality with a central order book. This model is very similar to the European Alliance Market Model that was agreed by the group of eight Alliance Exchanges on 23 September 1999 as the preferred model for the operation of an order book to support trading in liquid securities.

The JSE operates an order-driven, central order book trading system with opening, intra-day and closing auctions. The trading model, inter alia, provides for:

- Continuous automated trading;
- Opening and closing auctions;
- Optional Intra-day auctions;
- Limit , Market, Stop and Stop Limit order types;
- Pegged Hidden Orders and Pegged to Limit Hidden Orders;
- End of Day Volume Auction Call Session
- Central Order Book Cross Orders
- Order execution conditions;
- Order restrictions;
- Order validity constraints;
- Minimum Order Size (MOS) for visible orders;
- Minimum Reserve Size (MRS) and Minimum Execution Size (MES) for Pegged Hidden limit orders;
- Price-visibility-time continuous trading matching rules;
- Auction price based upon maximum executable volume with minimum surplus, market pressure and reference price criteria;
- Auction call period extensions;
- Static and Dynamic Price Monitoring;
- Auction, Volume Weighted Average Price (VWAP) and MID closing prices;
- Lot size of 1 for every instrument;
- Tick size of 1 for every instrument

---

## 4 JSE MARKET STRUCTURE

The structure of the JSE market is based on the following hierarchy:

		<b>Example</b>
<b>Market</b>	Used to describe the geographical elements of a trading environment – its business calendar and time zone the Market is operating in.	JSE
<b>Trading Segment</b>	The segment is a logical grouping of instruments. Trading cycles and trading sessions are defined at this level.	ZA01
<b>Instrument</b>	The lowest tier is used to describe the individual tradable instrument itself Trading parameters are defined at an instrument level.	AGL

The table below illustrates how the trading system is segmented for the JSE and NSX markets in order to facilitate efficient control of trade (note that this segmentation is purely for configuration of the trading system and is not a representation of how the market itself is classified e.g. Financials, Industrials).

Some of the details indicated below will be included in the Reference Data distributed daily to the market.



SEGMENT CODE	SEGMENT NAME	DEFINITION	MAXIMUM ORDER SIZE	LIQUIDITY RATING
ZA01	Top Companies	Order driven trade of: Top40 Constituents; JSE/UK dual listed	99,999,999	1 or 2
ZA02	Medium Liquid	Order driven trade of: JSE instruments with a liquidity rating of 1 or 2 but do not form part of the TOP40 Constituents and JSE/UK Dual listed instruments; Debentures; Preference Shares; Kruger Rands;	99,999,999	1 or 2
ZA03	Less Liquid	Order driven trade of: Remaining JSE instrument with a liquidity rating of 1, 2 or 3; All Nil Paid Letters; All instruments that meet the listings requirements for the Alternative Exchange Board; All instruments that meet the listings requirements for Black Economic Empowerment	99,999,999	1, 2 or 3
ZA04	Specialist Products	Order driven trade of: Warrants; Investment Products; Other Securities	99,999,999	3
ZA06	Exchange Traded Products	Order driven trade of: Exchange Traded Funds; Exchange Traded Notes	99,999,999	ETF=1 ETN=3
ZA11	NSX Local	Order driven trade of: NSX local instruments	99,999,999	1,2 or 3
ZA12	NSX/JSE Dual Listed	Order driven trade of: JSE/NSX dual listed instruments	99,999,999	1,2 or 3

**\*\* Please refer to Appendix D for the calculation of the Trading Liquidity**

---

## 4.1 Market Definition

The following parameters are defined and maintained for the market:

Parameter	Description
Market ID	Unique name identifying the market instance e.g. JSE / NSX
Time Zone	This will be SAST for the JSE and NSX.
Start / End Time	As defined for the market.
Calendar ID	Each market will be associated with its own trading calendar to define various automations within the system such as public holidays when the system should not automatically start trading.
Status of the Market	Active or Suspended

## 4.2 Market Segmentation

The following parameters are defined and maintained for a market segment:

Parameter	Description
Segment Code	Code used to identify the segment. e.g. ZA01; ZA02
Segment Name	Description of the Segment. e.g. ZA01 – JSE Top Companies
Segment Status	Indicates if the Segment is Active or Suspended.
Segment Trading Cycle	Defines a list of trading sessions (and associated times) for a trading day. Trading Sessions define a set of trading rules during a particular phase of a trading day.
Session Parameters	Defines whether price monitoring, hidden orders or extensions to the auctions are allowed.
Closing Price Methodology	Defines which closing price methodology will be used.

---

### 4.3 Instrument Definition

The following parameters are defined and maintained for an instrument:

Parameter	Description
Symbol	The JSE alpha code assigned to the instrument.
Instrument ID	Unique numeric Code assigned to the instrument.
Description	Description of the Instrument.
Market ID	Defines the market to which the Instrument belongs e.g. JSE.
Segment	The market segment where the instrument is traded.
ISIN	International Securities Identification Number assigned to the instrument.
Reference Price	May be used to specify a base price for a new instrument until a market price is established. This will not be populated for the JSE and NSX markets.
Currency	The trading currency for the instrument. This will be ZAC (South African Cents) for the JSE markets.
Minimum Reserve Size	Applicable to Pegged Hidden Orders
Price Improve Ticks	The number of ticks by which the price is to be improved for hidden orders. This value will be defaulted to 0.5.

Corporate Action Indicators (Ex-Markers and Annotations) are also maintained in the system and can be assigned to an instrument with 'Effective From' and 'Effective To' date parameters.

## 5 JSE MARKET PARTICIPANT STRUCTURE

The system can accommodate the following client hierarchy:

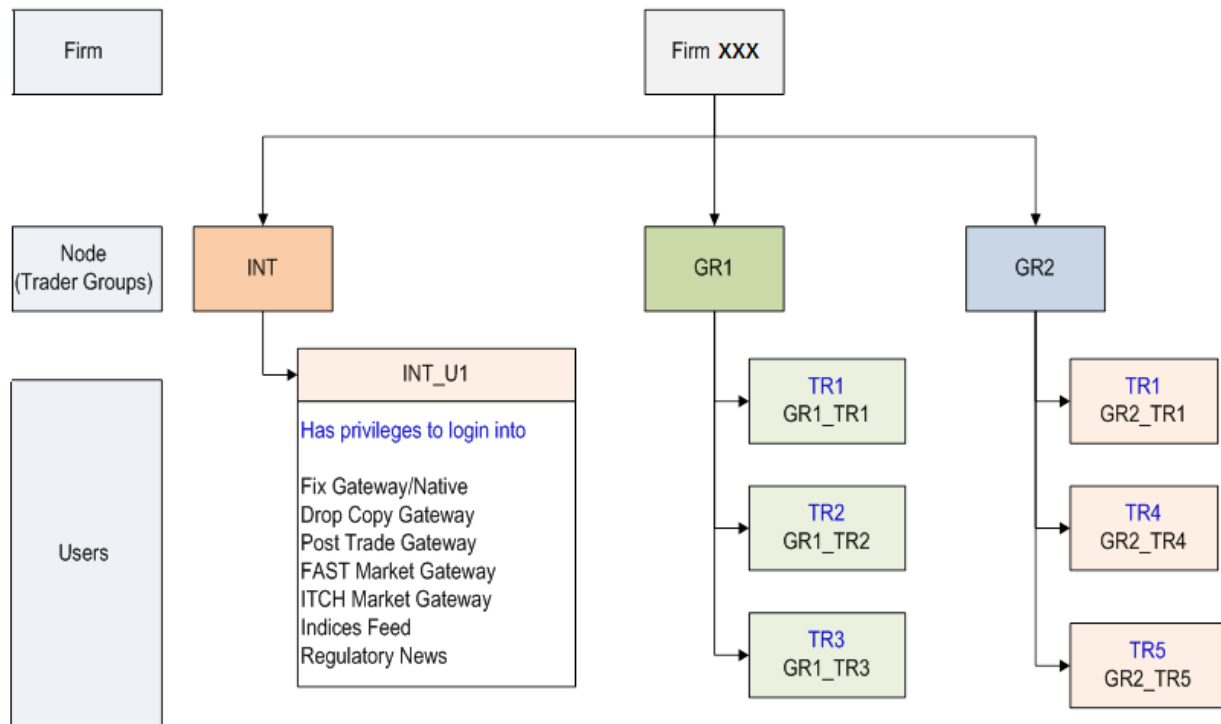

This structure supports the identification of desks and/or individuals (Trader ID) within a trading entity (Trader Group), such as cash desk, arbitrage, international brokers, direct market access and automated trading systems.

Member ID (Firm)	The highest level for depicting a Participant – this is intended to correspond to the firm’s highest entity.
Trader Group (Node)	This will be configured to meet Participant requirements. Each firm will however be allocated a group of “Trader’s” to manage their interface to the JSE system. This will be invisible to the participant but will form part of the enablement process.
Trader ID (User ID)	Each Trader will be allocated to each trader Group defined for the Participant. This will provide Participants with the flexibility to trade across Trader groups if required. This must be managed internally by the Participant.

### 5.1 Types of Users (Roles)

Users are allocated roles in the system depending on the function they will be performing:

#### 5.1.1 Traders

A Trader is a market user that submits orders and submit Off Book trades to the System by routing the order and trade through an Interface user login. A Trader will have permission to:

- 
- Submit orders to the system
  - Manage orders existing on the system (amend / cancel)
  - Submit and manage Off Book trades.

Each trader must be registered with the JSE. Upon registration, each trader is assigned a unique ID which must be included in all orders and trades submitted by the trader through the Interface user.

### **5.1.2 Interface users**

An Interface user will be granted permission to log into one or more Interface(s). These users will not be visible to the other users in the system. The configuration of Interface users is firm specific and is defined during the process of enabling Firms on the System.

### **5.1.3 Information Subscribers**

An Information subscriber is a market user who has privileges to receive news and market data updates from the exchange as per their specific privileges. Information subscribers will be configured in much the same way as trading participants. The configuration of interface users would also be firm specific.

---

## 6 INSTRUMENT MANAGEMENT

### 6.1 Unique Identification of Instruments

The JSE identifies each listed instrument on the Trading System by the unique Instrument ID assigned to it. This code is automatically assigned to an instrument when it is created in the JSE Reference Data System.

Upon creation of an instrument, a Corporate Actions Indicator Table (for Annotations and Ex-markers) is automatically created. The table ID assigned is the same as the symbol (alpha code). See Appendix B for a list of valid Annotations and Ex-markers.

If the Instrument ID or the Symbol of an instrument is changed, any open orders associated with that instrument will automatically be deleted.

### 6.2 Exchange Market Size (EMS)

The EMS is used to define the requirements for certain Off Book Trades.

The trading pattern for instruments is influenced by various economic factors. As part of its regulatory responsibilities, the JSE constantly reviews the Exchange Market Size (EMS) bands, Minimum Reserve Size (MRS) bands, functional segment allocation as well as the trading liquidity for all listed equity instruments to ensure that trading can be conducted effectively:

- For all trading segments, the EMS is calculated as a percentage of the Average Daily Volume of on-book trades for an instrument over a 12-month period.

The bulk of the reallocations will be scheduled to coincide with the quarterly JSE/FTSE indices review but changes may be made on an ad-hoc basis.

#### **EMS Calculation for all trading segments**

The actual EMS of the instrument is calculated as 5% (i.e. 1/20<sup>th</sup>) of the Average Daily Volume of the on-book trades for an instrument over the last 12 months.

**Average Daily Volume (of on-book trades) =**

**Actual EMS =  $\frac{\text{AVERAGE DAILY VOLUME}}{20}$**

20

### 6.3 Minimum Reserve Size (MRS)

For orders to qualify as hidden, the order Volume at the point of entry or modification of the order must be equal to or greater than the MRS defined for that instrument as specified by the JSE. The MRS for all instruments in ZA01, ZA02, ZA03 and ZA06 is set to the equivalent number of shares making up R10 million. Every evening the closing price is used to calculate the MRS value by dividing R10 million by the closing price. This will produce the number of shares that are allowed to be placed as fully hidden orders on the trading system.

e.g. the JSE instrument has a closing price of 10,800c and will result in a MRS = 92,592.

$$\text{MRS} = \text{R}10,000,000 / \text{R}108.00 = 92,592$$

---

The table below depicts the MRS calculation for all segments.

SEGMENT	MRS CALCULATION
All	R10 Mil Value

Pegged Hidden orders which do not meet the specified MRS upon entry or modification will be rejected. Pegged Hidden orders that do meet the necessary MRS after a partial fill (i.e. the remaining order size is below the MRS threshold), will be removed from the central order book.

See Appendix F for examples of when Hidden Orders will be rejected/expired.

## 6.4 Minimum Execution Size (MES)

Minimum Execution Size (MES) needs to be specified on every Pegged Hidden Limit order and honoured during the initial aggression of the order as well as later executions when the order persists in the order book.

MES:

- must be specified on all Pegged Hidden Limit orders;
- must be a multiple of the instrument Lot size;
- must always be equal to or greater than MRS;
- is ignored during auctions as the purpose of the algorithm is to maximize volume execution; and
- may be amended on unexecuted orders.

## 6.5 Futures Close-Out

### Quarterly Futures Close Out

On a Quarterly Futures Close Out Day, all equity market instruments will move into the FCO Auction Call Session.

These instruments will have a Futures Close Out Trading Cycle attached. This information is available in the client trading reference files.

### Monthly Futures Close Out

Monthly Futures Close Out (i.e. Jan, Feb, Apr, May, Jul, Aug, Oct and Nov) auction will utilise the Equity Market End of Day (EOD) Closing Auction.

The EOD Closing Auction will therefore be used to determine close out values for the instruments expiring on those days.

On a Monthly Futures Close Out instruments that are expiring on the day will follow a Standard Trading Cycle.

---

## **6.6 Instrument Suspension**

The JSE may suspend an instrument Intra-Day. Upon suspension of an instrument, all open orders associated with that instrument are automatically deleted and a closing price will be disseminated. The JSE will issue a Market Operations Announcement informing the market of the suspension.



---

## 7 SESSION MANAGEMENT

The JSE has the ability to manually invoke certain trading sessions should the need arise.

### 7.1 Halt/Resume a session

The JSE can halt instruments either by selecting individual instruments or by performing a mass halt. Upon halting an instrument, all open orders remain in the book. Users are able to delete orders but no new orders or amendment to orders may be submitted.

The JSE is also able to select any of the following criteria to perform a mass halt of instruments

- a) Market
- b) Segment

The JSE will issue a Market Operations Announcement informing the market of the halt/resumption.

Resumption of the halted instruments can also be done individually per instrument or by performing a mass re-opening. If trading in a halted instrument is resumed, then the instrument will move to a Resume Auction Call session for a time period defined by the JSE. At the end of the Resume Auction Call session, the System will use the Volume Maximising Algorithm to uncross the order book prior to moving to continuous trading.

### 7.2 Halt and Close session

When the JSE initiates the Halt and Close session, the closing price of the instrument(s) will be frozen i.e. the closing price will be calculated according to closing price methodology for that segment and published via the Market Data Gateways.

The session status of the instrument will be published as Halt.

### 7.3 Extend/Shorten sessions

The JSE has the ability to extend or shorten the allotted time for different trading sessions.

Times can be extended/shortened at the market, segment and instrument levels.

If the JSE extends the time of a session (e.g. by 10 minutes), the next session will start later and the JSE could choose to either:

- a) Automatically extend the end time of each subsequent session i.e. (each subsequent session will end 10 minutes later than usual) or
- b) Shorten the duration of the immediate next session (e.g. the duration of the immediate next session will be extended by 10 minutes while the other sessions will end at the usual time).

Sessions that do not have a specific time (e.g. Halt session) will not be extended/shortened.

The extension or shortening of a trading session is temporary and will only apply to the current trading day.

---

## 8 TRADING

This section describes the core order-driven trading functionality that is available to support trading in the JSE equity market.

### 8.1 Types of Orders

There are four orders types that may appear on the order book namely, Market, Limit (visible and hidden), Stop, and Stop Limit orders.

#### 8.1.1 Market Order (MO)

Market orders stipulate only the volume of shares for trade and do not specify any limit price. A Market Order will be executed against all the possible price levels on the contra side.

Market Orders submitted during the Continuous Trading session will execute against each contra order in the order book until it is fully filled. If, after executing against all orders in the order book there is a remainder, it will expire.

Market Orders that are submitted during an auction call session will reside in the order book until the uncrossing is performed at which point the remainder of unexecuted Market Orders will be expired.

#### 8.1.2 Limit Order (LO)

Visible Limit Orders stipulate both volume and limit price. A Limit order may execute at prices equal to or better than its limit price. The volume in the visible size field is equal to the order volume.

If after executing against all appropriately priced orders in the order book there is a remainder, it will be added to the order book or expired based on the Time in Force (TIF).

#### 8.1.3 Pegged Hidden Orders

Hidden Limit Order functionality will be replaced and enhanced by the Pegged Hidden Order and Pegged Hidden Limit Order functionality. These will be referred to as Hidden Orders interchangeably.

Hidden orders allow participants to enter Pegged Hidden Order and Pegged Hidden Limit Order in the order book without displaying either price or volume to other participants. Hidden orders are able to interact with both visible and other hidden orders on the order book. The two new order types that participants can enter are Pegged Order and Pegged Limit Order. The volume in the visible size field must be zero.

Clients can peg a Buy Hidden Order to either the Best Bid or the Mid-Point and a Sell Hidden Order to either the Best Offer or the Mid-Point.

This is dependent on how the trading segment is configured on the Trading Engine as depicted below:

**Table: Pegged Hidden Order configuration setup**

Segment	Pegged Hidden Order applicable
ZA01; ZA02; ZA03; ZA04	All
ZA06	Pegged-to-Mid only

All Hidden orders must carry a Minimum Execution Size (MES) which will be considered on executing Hidden orders. The MES will be honoured during the initial aggression of the order as well as later executions when the order persists in the order book. The MES must be:

- 
- A multiple of the Lot Size of the instrument; and
  - Equal to or greater than the Minimum Reserve Size (MRS) of the instrument.
  - Hidden Orders may only be submitted during the following sessions:
    - Opening Auction
    - Continuous Trading
    - Volatility / Intra-Day / FCO / Re-Opening Auction Call
  - It will be possible to submit a new pegged order or amend existing pegged orders even if there is no mid-point, visible best bid or offer. However in such scenario the pegged order will remain in an inactive state
    - a) If mid-point is not available all pegged orders pegged to the Mid-Point will be in an inactive state
    - b) If best bid is not available all pegged orders pegged to the Bid will be in an inactive state
    - c) If best offer is not available all pegged orders pegged to the offer will be in an inactive state
  - MES specified on Hidden orders will be ignored during any Auction Call session.
  - Hidden orders can only have the following time qualifiers:
    - DAY
  - On aggression, if the MES of a Hidden order cannot be satisfied, the order will either be added to the order book or expired (based on the time in force of the order).
  - On partial execution of a Hidden order (aggressing the order book or residing in the order book), the following will apply (see examples in appendix E) :
    - If the quantity remaining on the order is < Minimum Reserve Size → Order will be expired
    - If the quantity remaining on the order is  $\geq$  Minimum Reserve Size but < MES → Order will be expired
    - If the quantity remaining on the order is  $\geq$  Minimum Reserve Size and  $\geq$  MES → Order will remain in the book or expired (based on the 'Time in Force' of the order).

#### 8.1.4 Pegged Hidden Limits Orders

A pegged order when submitted with a limit price is considered as a '*Pegged Hidden Limit Order*.' The hard limit should be considered breached for a:

- Buy pegged order, pegged to the mid, if the mid-price  $\geq$  hard limit price of the order
- Buy pegged order, pegged to the bid, if the best visible bid price  $\geq$  hard limit price of the order
- Sell pegged orders, pegged to the mid, if the mid-price, if mid-price  $\leq$  hard limit price of the order
- Sell pegged orders, pegged to the offer, if the best visible offer price  $\leq$  hard limit price of the order
- An aggressing pegged order that has breached the hard limit should be added to the book without any executions in an inactive state.
- A resting pegged order that has breached its hard limit will remain in an inactive state and reside in a non-executable state in the pegged order container itself.

- 
- During pegged order re-evaluation pegged orders that have breached the limit will not be considered. (These orders will be in an inactive state).
  - An inactive pegged order will be considered active once the BBO/Mid-point changes so that the pegged order does not breach the specified hard limit anymore.
  - A client can modify a pegged order regardless of the active/inactive state.

Pegged Hidden and Pegged Hidden Limit Orders can reside in an active or inactive state. During an inactive state these orders will not be considered for execution nor lose time priority in the system. No communication is sent to inform clients of an order moving into and out of an inactive or active state.

Hidden order execution for orders pegged to the best bid or best offer will be subject to price improvement logic. This ensures that no execution can take place at the best visible price whilst disadvantaging a visible order in place of a hidden order. The price improvement will half a tick i.e. 0.5 ZAC. Please refer to Example [15.1.1.1](#) and [15.1.1.2](#).

### **8.1.5 Stop Order (SO)**

A Stop Order is a Market Order that will remain unelected (without entering the order book) until the stop price is reached. Once elected, it will be treated similar to a regular new Market Order.

A SO with a 'Time in Force' of OPG, GFA, GFX ATC and CPX will be rejected.

A SO with a 'Time in Force' of DAY, GTC, GTD and GTT are permitted to be entered during the auction call sessions but will only be elected in the Continuous Trading session following the auction call session in which it was entered.

### **8.1.6 Stop Limit Order (SL)**

A Stop Limit Order is a Limit Order that will remain unelected (without entering the order book) until the stop price is reached. Once elected, a SL order will be treated similar to a regular new Limit Order.

A SL with a 'Time in Force' of OPG, GFA, GFX ATC and CPX will be rejected.

A SL with a 'Time in Force' of DAY, GTC, GTD and GTT are permitted to be entered during the auction call sessions but will only be elected in the Continuous Trading session following the auction call session in which it was entered.

#### **8.1.6.1 Election Rules for Stop and Stop Limit Orders**

The trigger for electing Stop and Stop Limit orders will be the last traded price.

- Stop and Stop Limit buy orders will be elected if the last traded price is equal to or greater than the stop price
- Stop and Stop Limit sell orders will be elected if the last traded price is equal or less than the stop price.

An incoming Stop or Stop Limit order may be immediately elected on receipt if the stop price has already been reached.

If the triggering price is not available (e.g. last traded price does not exist), incoming Stop and Stop Limit Orders shall not be elected on entry and will be parked

Stop and Stop Limit orders will be elected only at the end of the execution of an order i.e. if an aggressing order is sweeping multiple price points of the order book, Stop/Stop Limit Orders are elected only once the aggressing orders has completed its execution.

#### **8.1.6.2 Election Priority for Stop and Stop Limit Orders**

After a trade has occurred, if there are multiple Stop or Stop Limit orders to be elected, the election priority will be as follows:

- 
- Orders will be elected in terms of the difference between their stop price and the auction price.
    - The buy or sell order with the greatest difference between its stop price and the auction price will be elected first.
    - If multiple orders are at the same difference (buy and sell), the oldest order will be elected first.

Refer to Appendix G for examples of a Stop and Stop Limit order.

### 8.1.7 Central Order Book Cross

A cross order is a limit order with a Time in Force validity of DAY. This is an Internal Cross / Single Sided cross where the pre-negotiated trade is entered within a single member firm. The Cross order message will require both buy and sell order details. The traded price will always be within the visible best bid and offer price. Cross orders cannot be hidden orders and will not trigger a Volatility Auction Call session upon execution.

Clients will be able to determine what pricing method should be applicable to the Cross Order. If traders do not want the Cross Order price to be modified they can select the 'Fixed Price' option when submitting the Cross Order. Traders that would prefer guaranteed execution will select the 'Adjustable Price Option'.

A trade resulting from the submission of a Cross Order results only in a Cross Trade (XT) and has no impact to orders.

#### Cross Orders with Fixed Price

Cross orders can only be submitted with a price within the best bid and offer price (BBO) of the instrument (excluding the BBO).

- a) When the BBO is available, the system will validate the price against the spread within the best bid and best offer price of the instrument.
- b) If only the best bid (or best offer) is available, the cross order should be better than the available best bid (best offer).
- c) If both the best bid and best offer is not available, the cross orders will be checked against a range defined around the Dynamic Reference Price. The system will accept cross orders with price within but not including the boundary values.
- d) If the Dynamic Reference Price is not available, the cross order will be rejected.
- e) If the percentage value defined in the system for the applicable cross order price range is 'Null' or 0, the submitted cross order will be rejected.

#### Cross Orders with Adjustable Price

Clients are able to flag whether a Cross Order being submitted is fixed price or adjustable price.

If the Cross Order is identified as a 'fixed price' Cross Order, and the submitted price does not conform to the applicable price range, the Cross Order will be rejected. However, if the Cross Order is identified as an 'adjustable price' Cross Order, the following will apply:

- a) When the BBO is available, the system will validate the price against the spread within the Best Bid and Best Offer price of the instrument. If the price is out of the BBO spread, then the system will update the price of the Cross Order to be the mid-point of Best Bid and Best Offer (The system will adjust the Cross Order price to half a tick if the BBO spread is only 1 tick).
- b) If only the Best Bid (or Best Offer) is available, the Cross Order should be better than the available Best Bid (best offer). If Cross Order price is worse than best bid (or best offer), system will adjust the price of the Cross Order to be half a tick (value defined in the 'PricImproveTks' parameter for the instrument) better than the Best Bid (or Best Offer).

---

c) If both the Best Bid and Best Offer are not available, the Cross Orders will be checked against a range defined around the Dynamic Reference Price (value defined in the Ref Price Allowance (%) parameter of the instrument). The system will accept Cross Orders with a price within but not including the boundary values.

### 8.1.8 Iceberg Orders

An Iceberg Order includes an instruction to not show more than some maximum quantity of the unfilled order. Iceberg Orders allow Participants to only display a smaller portion of the total quantity to the market in order to minimise potentially unfavourable market impact costs associated with large orders.

In this way, for a large order that would represent a substantial amount of the average daily trading volume of a security, a trader concerned about unfavourable price movements due to the full extent of his interests being revealed, may benefit from using Iceberg Orders.

Iceberg Orders can be Limit, Market, Stop or Stop Limit Orders and may be submitted with any of the supported TIFs.

When entering an Iceberg Order, a disclosed (visible) quantity must be specified in addition to the order (total) quantity. The system will then recognise the order as an Iceberg Order comprised of a visible portion and a hidden portion. The specified visible quantity is the maximum volume that will be shown to the market during the life of the order. There is currently no minimum limit on the visible quantity or order value.

When executing as an aggressing order, Iceberg Orders behave similar to regular orders on entry whereby they seek to execute their quantities in full. At the end of the aggression, any remainder is added to the order book. The quantity displayed will be the lower of the specified visible quantity and remaining quantity.

When executing as a passive order, Iceberg Orders will first execute with their visible quantities, against the aggressive order, at the best price point. Once all of the visible quantities at a given price point are exhausted, and if the aggressive order still has an unexecuted quantity, the hidden quantities of the passive Iceberg order will execute. The aggressing order will aim to execute its full remaining quantity against the hidden portion of the Iceberg Order.

Should there be multiple Iceberg Orders at the same price point, the remainder of the aggressing order will execute against the hidden portions of the Iceberg Orders in a pro-rated fashion. (refer to example 18.1.3 in Appendix 18)

Once the aggressing order is fully exhausted, the system will replenish the visible size from the remaining hidden order quantities. This replenishment will occur according to a random replenishment methodology, in order to ensure that the Iceberg Order is not easily identifiable on the public order book. The replenishment will be a random volume within an upper and lower limit, as defined below:

$$\text{Lower Limit} = \text{Initial Visible Quantity} \times [1 - \text{Random Replenishment \%}]$$

$$\text{Upper Limit} = \text{Initial Visible Quantity}$$

In addition to the order identifier 'Order ID', a second known identifier called 'Public Order ID' will be assigned to each order. Upon order entry, the Public Order ID will be the same as the Order ID. For Iceberg Orders, the Public Order ID will change with each replenishment to the visible order size, whilst the Order ID will remain constant.

Amendments of Iceberg Orders are treated the same as normal orders. An amendment to increase the order quantity will result in a loss of time priority, while a decrease will maintain time priority. In addition, if the order quantity is unchanged, but the visible size (i.e. display quantity) is increased, the order will lose time priority. While, if the order quantity is unchanged, and the visible size is decreased, the order will maintain time priority.

During an Auction Call session, Iceberg Orders will participate in the price formation with their full quantities, even though only the visible portion will be displayed on the public order book.

---

## 8.2 Order Attributes

The following fields may be specified when an order is submitted:

Field	Required	Description
Instrument ID	Yes	Unique identifier of the security.
Side	Yes	Whether the order is to buy or sell.
Order Type	Yes	The type of the order.
Time in Force	No	The duration the order is valid for. If the time in force is not stated, the System assumes it to be a DAY order.
Order Quantity	Yes	The quantity being bought or sold. This should be a whole number that is greater than zero and must be a multiple of the instrument's Lot size.
Visible Size	No	This will be zero for Pegged Hidden and Pegged Hidden Limit orders.
Price	No	The maximum / minimum price a buy/sell order may be executed at. This value should be greater than zero and a multiple of the instrument's 'tick' size. This field is required if the order is a Limit, Hidden or Stop Limit Order.
Stop Price	No	The price at which the order may be elected. This value is required if the order is a Stop or Stop Limit order or Pegged Hidden Limit Order. This value should be greater than zero and a multiple of the instrument's tick size.
Capacity	Yes	Denotes if the order is entered as an Agency (on behalf of a client) or Principal (own account).
Expiry Time	Required if 'Time in Force' = GTT	The time at which an order with GTT 'Time in Force' should expire on the current day.
Expiry Date	Required if the 'Time in Force' = GTD	The date on which an order with GTD should expire.
Trader	Yes	The unique five digit code assigned by the JSE.



Trader Group	Yes	The group that the trader belongs to and represented by a node in the System.
Client Account	Yes	The 8 digit mandatory client account as supplied by the JSE.
MES	Yes (for hidden orders)	The mandatory Minimum Execution Size for a hidden order.
MRS	Yes (for hidden orders)	Minimum Reserve Size - the minimum order volume for orders to qualify as Hidden Limit orders. All Hidden orders are validated against this parameter.
Client Order ID	Yes	Unique client identifier field
Secondary Client Order ID	Yes	Unique client identifier field (Note: this is only applicable for the FIX Trading Gateway)
Execution Instruction	N	Include in Volume Auction Uncross

The following fields may be specified when a Central Order Book Cross order is submitted:

Field	Required	Description
<b>Header</b>		
Cross ID	Y	An identifier of the cross order. This will be unique across the trading day. Required for cross orders. Only Alpha numeric values will be allowed in this field. No special characters will be allowed.
Cross Type	Y	The type of the cross order: <b>Value Meaning</b> 5 Internal Cross Any other value will be rejected via a Reject message
Buy Side Client Order ID	Y	Client specified identifier of the buy side. This is a required field
Buy Side Capacity	Y	Capacity of the buy side. <b>Value Meaning</b> 2 Principal 3 Agency Any other value will be rejected via a Reject message.
Buy Side Trader Mnemonic	Y	This will be the concatenated identifier of the JSE Trader ID and the Trader Group the trader belongs to. (Mandatory). The concatenation will be done by using an underscore between the JSE Trader ID and Trader group identifier.
Buy Side Account	Y	Client Account information of the buy side This is the Client Account of the firm who is sending the buy side of the cross order. This is a required field. Only numeric values will be allowed.
Sell Side Client Order ID	Y	Client specified identifier of the sell side. This is a required field.
Sell Side Capacity	Y	Capacity of the sell side. <b>Value Meaning</b> 2 Principal 3 Agency Any other value will be rejected via a Reject message.
Sell Side Trader Mnemonic	Y	This will be the concatenated identifier of the JSE Trader ID and the Trader Group the trader belongs to. (Mandatory). The concatenation will be done by using an underscore between the JSE Trader ID and Trader group identifier.
Sell Side Account	Y	Client Account information of the sell side. This is the Client Account of the firm who is sending the sell side of the cross order. This is a required field. Only numeric values will be allowed.
Security ID	Y	Numeric Identifier of the instrument for which the cross order is submitted.(Instrument ID)
Order Type	Y	Type of the order. <b>Value Meaning</b> 2 Limit Any other value will be rejected via a Reject message.

Time In Force	Y	Time qualifier of the order. Only DAY TIF is allowed for cross orders. <b>Value    Meaning</b> 0        Day
Limit Price	Y	Limit price. This field will be ignored if the Order Type is not Limit (2) or Stop Limit (4).
Order Quantity	Y	Total order quantity of the cross order

### 8.2.1 Order Capacity

Orders can be designated by one of the following capacities:

- Agent (A)
- Principal (P)

### 8.2.2 Order Side

An order can be either a Buy (B) Order or Sell (S) order.

### 8.2.3 Time in Force Order Validity

The System supports twelve time in forces: DAY, IOC, FOK, OPG, GTC, GTT<sup>1</sup>, GFA, GFX, ATC, GTD CPX, AND GDX

It should be noted that the TIF on orders cannot be amended. If the TIF needs to be changed, the order needs to be deleted and re-submitted with the correct TIF.

Market and Limit orders can be subject to the following validity periods:

#### 8.2.3.1 At the Opening (OPG)

OPG time in force is used to direct orders to the Opening Auction.

OPG Orders will only be accepted if submitted during the Opening Auction session.

OPG orders may participate in the uncrossing of the Opening Auction and are included in the calculation of the Indicative Auction Information. The remainder of these orders will expire at the end of the Opening Auction uncrossing.

If an OPG order is sent for an instrument which does not have a scheduled Opening Auction or the scheduled Opening Auction session has already occurred, it will be rejected.

If the JSE manually invokes a different session during the Opening Auction call session, then it is considered a session change and all OPG orders will expire.

#### 8.2.3.2 Good for Auction (GFA)

GFA time in force is used to direct orders to the next auction (which may or may not be scheduled). They will not be executed during Continuous Trading.

The next auction could be the Opening Auction call, Volatility Auction call, Resume Auction call, Intraday Auction call or the Closing Auction call session.

GFA orders may participate in the uncrossing of the Auction and are included in the calculation of the Indicative Auction Information.

At the end of an auction call session, the remainder, if any, of a GFA order will be removed from the regular order book and parked for the next Auction until the remainder of the order is fully filled/ cancelled.

GFA orders submitted during the Continuous Trading session will be parked until the next auction call period starts at which point they will be injected into the order book.

If there is no auction call session (scheduled or unscheduled) triggered for the day, the GFA orders will be expired at Market End on the trading day that they are submitted.

---

#### 8.2.3.3 **Good for Intraday Auction (GFX)**

GFX time in force is used to direct orders into the Intraday Auction. GFX orders may participate in the uncrossing of the Intra-day auction and are included in the calculation of the Indicative Auction Information. The remainder of these orders will expire once the uncrossing is completed.

GFX orders submitted during the Continuous Trading session and any Auction session other than the Intraday Auction session will be parked until the Intraday Auction Call period starts at which point they will be injected into the order book.

If there is no Intraday Auction session scheduled (as may be the case in some Segments on the JSE) for the day the GFX orders will be rejected.

The remainder, if any, of GFX orders will expire following the uncrossing of the auction.

If the JSE manually invokes a different session during the Intraday Auction call session, then it is considered a session change and all GFX orders will expire.

If any GFX orders are remaining after the Intraday Auction call session due to manual session extensions after the Intraday auction call session, they will expire at Market End on the trading day that they are submitted.

#### 8.2.3.4 **At the Close (ATC)**

ATC time in force is used to direct orders to the Closing auction.

ATC orders may participate in the uncrossing of the Closing Auction and are included in the calculation of Indicative Auction Information. The remainder of these orders will expire once the Closing Auction uncrossing is completed.

ATC orders submitted during the Continuous Trading session will be parked until the Closing Auction Call period starts at which point they will be injected into the order book.

If there is no Closing Auction scheduled for the day, the ATC orders will be rejected.

If the JSE manually invokes a different session during the Closing Auction call session then it is considered a session change, and all ATC order will expire.

#### 8.2.3.5 **Day (DAY)**

Orders with the DAY Time in Force will be expired at Market End of the trading on the day they are submitted. Please note that in all cases where a TIF is not specified on an order, it will default to DAY and will behave accordingly.

#### 8.2.3.6 **Immediate or Cancel (IOC)**

Orders with IOC time in force (except for Stop and Stop Limit orders) will be rejected during Auction Call sessions.

An IOC order may be partially filled. Orders with the IOC time in force (except for Stop and Stop Limit orders) will be executed on receipt and the remainder, if any, will be immediately expired.

Stop and Stop Limit orders with IOC time in force will be accepted during Auction Call sessions and Continuous Trading sessions and stored in the Order Book until its Stop price is triggered.

#### 8.2.3.7 **Fill or Kill (FOK)**

Orders with FOK time in force (except for Stop and Stop Limit orders) will be rejected during Auction Call sessions. These orders will (except for Stop and Stop Limit orders) will either be fully executed on receipt or immediately expired.

Stop and Stop Limit orders with FOK time in force will be accepted during Auction Call sessions and Continuous Trading sessions and stored in the System until they are elected i.e. their Stop price is triggered.

---

#### 8.2.3.8 **Good till Cancel (GTC)**

The Maximum Order Duration for GTC orders is 90 calendar days (not trading days) for all segments defined in the JSE Market Model. Orders will remain in the Order Book until:

- Fully filled
- Cancelled
- Expiry date is reached.

The expiry day is calculated from (including) the order submission date and once the expiry date is reached, the order will be automatically expired at the start market period on the 91<sup>st</sup> day.

If a GTC order is amended, the re-submission date is not updated and the expiry will still be calculated on the original order submission date irrespective of the change made. Change to the volume or price of an order that may impact the price or time priority of the order will not impact the calculation of the expiry date which will always be based on the original order entry date.

#### 8.2.3.9 **Good till Date (GTD)**

GTD orders will remain in the System only for the specified duration or until they are:

- Fully filled
- Cancelled
- Until it reaches its specified expiry date.

As an expiry time cannot be specified for GTD orders, if an expiry time is specified along with an expiry date for a GTD order, the order will be rejected.

GTD orders will be accepted and expired upon breaching the Maximum Order Duration (90 calendar days) or the specified expiry date whichever comes first.

When submitting a GTD order, only the expiry date must be specified in the following format: YYYYMMDD.

#### 8.2.3.10 **Good till Time (GTT)**

GTT orders are only valid till a specified time for the current trading day. Orders with the GTT time in force will expire at the time specified on the order or at the start Post Close session. These orders must contain a valid expiry time. GTT orders will not be expired during any Auction Call session even if the expiry time of the order falls within the auction time; any unexecuted GTT orders will be expired after the uncrossing of the auction. The orders can still be cancelled by the Trader during the Auction Call session.

The expiry time for an order can be specified in seconds.

When submitting a GTT order, the expiry date and time must be specified in the following format:

YYYYMMDD-HH:MM:SS

#### 8.2.3.11 **Closing Price Cross (CPX)**

Orders with this time qualifier are directed to the Closing Price Cross session. They may be entered during other sessions that accept orders but they stay parked in the parked queue until the Closing Price Cross session starts.

CPX orders are only valid for the current trading day and unexecuted CPX orders will expire at the end of the Closing Price Cross session. CPX orders can only have the order types Limit and Market. Stop/ Stop Limit CPX orders will be rejected by the System.

---

At the start of the CPX session, parked CPX orders will be injected to the normal order book if they satisfy the following conditions:

- The price of the parked CPX order is equal to the published Closing Price; or
- The price of the parked CPX order is better than the published Closing Price. *E.g. On the Buy side of the order book, if the published closing price is 100 ZAC and the CPX order price is 101 ZAC then the CPX order is re-priced to 100 and will participate in the CPX session.*
- Parked CPX orders with worse prices than the published Closing Price will be expired at the start of the Closing Price Cross session. *E.g. On the Buy side of the order book, if the published closing price is 100 ZAC and the CPX order price is 99 ZAC then the CPX order is expired and will not participate in the CPX session.*

At the start of the Closing Auction Call Session all eligible pegged orders will be injected into the bottom of the GDx Container

#### 8.2.3.12 **Good for EOD Volume Auction (GDx) – this functionality is currently disabled**

Orders with this time qualifier are directed to the EOD Volume Auction Session. GDx orders can be submitted during other sessions but will remain parked until the EOD Volume Auction.

GDx time in force will allow for non-visible uncrossing of large orders in the EOD Volume Auction Call, after the close of the CPX Session. GDx orders have to be large in size and the Minimum Reserve Size (MRS) will be validated. GDx orders can only have the order types Limit and Market.

Orders that are remaining in the Central Order Book at the end of the CPX session can participate in the volume uncrossing if these orders have opted to participate in this session (no MRS validations will be done on these orders)

Pegged orders can participate for execution in this session if they have a hard limit and have opted in to participate in this session, Time priority will be maintained. MES will be ignored during the uncrossing

The table below shows how each TIF, order type and order attribute is validated against each other:

Allowed
  Functionality disabled  
 Rejected
  NA

	IOC	FOK	DAY	GFA	GFX	OPG	ATC	GTC	GTD	GTT	CPX	GDX	Market	Limit	Stop	Stop Limit	Cross Order	Pegged Hidden	Pegged Hidden Limit	
IOC																				
FOK																				
DAY																				
GFA																				
GFX																				
OPG																				
ATC																				
GTC																				
GTD																				
GTT																				
CPX																				
GDX																				
Market																				
Limit																				
Stop																				
Stop Limit																				
Cross Order																				
Pegged Hidden																				
Pegged Hidden Limit																				





---

## **8.3 Order Management**

### **8.3.1 Cancellation**

A request to cancel an order will be rejected if the order is not an Open (unfilled order or the remaining quantity on a partially filled order) or Parked Order (unelected or uninjected).

At the request of the client, the server can be configured to automatically cancel all Open and Parked orders submitted under an Interface User ID (CompID) whenever it disconnects from the server. Please refer to JSE Specification Document Volume 01 - Native Trading Gateway and JSE Specification Document Volume 02 - FIX Trading Gateway (FIX 5.0 SP2) for more information.

### **8.3.2 Amendment of Open Orders, Parked Orders and Hidden Orders**

The following attributes of an order can be amended:

- Order quantity
- Minimum Execution Size
- Limit price
- Expiry date of GTD orders
- Expiry time of GTT orders
- Client Account Number

Amendments to increase order quantity (whether the order is Visible or Hidden) will cause the order to lose time priority. This will cause the order to re-aggress the order book. A reduction in the order quantity (whether the order is Visible or Hidden) will not cause a loss of time priority.

Amendments to price will cause the order to re-aggress the book. Therefore, this results in a loss of price and time priority.

Orders that move between the main container and the parked container will maintain time priority. Thus, orders that are allowed to trade in multiple auctions, such as GFA Orders, will be able to participate in multiple auctions without losing time priority. However, such orders will still lose time priority for amendments whereby the quantity (total or visible) is increased, or the price is amended (increased or decreased) in either the main container or the parked queue.

### **8.3.3 Client Account Amendment**

A Trader (user) may amend the original client account specified in the order. This must be done within the same trading day and can only be done for Open and Parked Orders. If the orders are neither parked nor open (such as orders which are expired, rejected, fully filled etc), the client reference amendment is not allowed.

Once a client account is changed, the amendment will only be reflected in the trade messages which are generated for subsequent trades.

The client account cannot be greater than 8 characters.

### **8.3.4 Amendment of Unelected Orders**

The following attributes of unelected Stop and Stop Limit Orders can be amended:

- Stop price
- Limit price
- Order quantity
- Expiry date of GTD orders

- Expiry time of GTT orders

Amendments that increase the order quantity will be treated as a new Stop Order being submitted to the System. Therefore, the order will lose time priority. Changing the stop price will be treated as a new Stop Order being submitted to the System. Therefore, the order will lose price and time priority. Amendments to the limit price or reducing the order quantity will not cause a loss in time priority within the unelected queue.

### 8.3.5 Own Order Book Download (OOBD)

A drop copy interface user with login privileges to the Drop Copy Gateway may request a download of all Open/Hidden /Parked Orders.

Such a request can be made at any time but the primary purpose of this functionality is to provide the Trader (user) with details of their open orders to assist them during a System recovery.

OOBD will always be requested for a Firm or a Trader Group/Trader Combination by a Drop Copy interface user. Users may also request the OOBD for a specific instrument or Segment.

If the request is successful, a copy of the execution report for all open orders for the particular Firm or Trader and Trader Group combination will be sent by the System.

There is a limit to the number of own order book download requests a drop copy user can submit within a trading day. This is limited to 1000 requests per day. Any request exceeding this amount will be rejected.

## 8.4 Daily Life Cycle

During a typical trading day, the system goes through a cycle of activities to ensure it is ready for trading. See below picture depicting the various activities for both the JSE and Users.

JSE System Health checks	JSE SOD Reference Data	Trading Engine Start up	Application Process start up	Start Day	Start Market	Trading Sessions	End Market	End Day JSE EOD activities	JSE Reference Data Updates	Reference Data Download
Daily Health Checks and Back-end proces start up	Data alignment checks performed on reference data prior to issuing updated files to clients	Start up trading processes	Users can log on to Gateways	Set Business Date	GTC and GTD orders expired, Market Data Gateway Security Definition published	On and Off Book Trading	Expire DAY orders Client re-quests satisfied	All users forcibly logged out from Gateways and EOD activity begins	JSE apply reference data updates to Trading System	Reference Data files available on FTP via IDP
04:15	04:30	04:50	05:15	06:15	06:30	08:00	18:30	20:00	21:40	22:30
04:30	04:50	05:15	06:15	06:30	07:00	18:15	20:00	21:40	22:30	04:50

## 8.4.1 Trading Sessions

### 8.4.1.1 Normal Day

The trading sessions for a Normal Day is reflected below:

#### NORMAL DAY - On Book Trades

SEGMENT	START OF TRADING	OPENING AUCTION CALL	CONTINUOUS TRADING	CONTINUOUS TRADING 1	INTRADAY AUCTION CALL	CONTINUOUS TRADING 2	CLOSING AUCTION CALL	CLOSING PRICE PUBLICATION	CLOSING PRICE CROSS	POST CLOSE
ZA01	07:00 - 08:30	08:30 - 09:00	09:00 - 16:50				16:50 - 17:00	17:00 - 17:02	17:02 - 17:10	17:15 - 18:15
ZA02	07:00 - 08:30	08:30 - 09:00	09:00 - 16:50				16:50 - 17:00	17:00 - 17:02	17:02 - 17:10	17:15 - 18:15
ZA03	07:00 - 08:30	08:30 - 09:00		09:00 - 12:00	12:00 - 12:15	12:15 - 16:50	16:50 - 17:00	17:00 - 17:02	17:02 - 17:10	17:15 - 18:15
ZA04	07:00 - 08:30	08:30 - 09:10	09:10 - 16:49					16:49 - 16:50		16:50 - 18:15
ZA06	07:00 - 09:00		09:00 - 16:50					16:50 - 16:52	16:52 - 17:00	17:00 - 18:15
ZA12	07:00 - 08:30	08:30 - 09:00	09:00 - 17:00				17:00 - 17:10	17:10 - 17:12	17:12 - 17:20	17:20 - 18:15
ZA11	07:00 - 08:30	08:30 - 09:00		09:00 - 12:00	12:00 - 12:15	12:15 - 16:50	16:50 - 17:00	17:00 - 17:02	17:02 - 17:10	17:10 - 18:15
Functionality allowed	View open/expired orders	Order entry/amendment /deletion	Order entry/amendment/ deletion; automatic matching	Order entry/amendment/ deletion; automatic matching	Order entry/amendment/ deletion	Order entry/amendment/ deletion; automatic matching	Order entry/amendment/ deletion	Closing price publication; order deletion	Order entry, order modification (except price), order deletion	Order deletion; GTT orders are expired

#### NORMAL DAY - Off Book Trades

SEGMENT	TRADE REPORTING	Post Close
ZA01	08:00 - 18:15	18:15 - 18:20
ZA02		
ZA03		
ZA04		
ZA06		
ZA12		
ZA11		
Functionality allowed	Manage Off Book trades	

### 8.4.1.2 Early Close Day

The trading sessions for an Early Close Day\* is reflected below:

#### EARLY CLOSE DAY - On Book Trades

SEGMENT	START OF TRADING	OPENING AUCTION CALL	CONTINUOUS TRADING	CONTINUOUS TRADING 1	INTRADAY AUCTION CALL	CONTINUOUS TRADING 2	CLOSING AUCTION CALL	CLOSING PRICE PUBLICATION	CLOSING PRICE CROSS	POST CLOSE
ZA01	07:00 - 08:30	08:30 - 09:00	09:00 - 11:50				11:50 - 12:00	12:00 - 12:02	12:02 - 12:10	12:10 - 13:00
ZA02	07:00 - 08:30	08:30 - 09:00	09:00 - 11:50				11:50 - 12:00	12:00 - 12:02	12:02 - 12:10	12:10 - 13:00
ZA03	07:00 - 08:30	08:30 - 09:00		09:00 - 11:00	11:00 - 11:15	11:15 - 11:50	11:50 - 12:00	12:00 - 12:02	12:02 - 12:10	12:10 - 13:00
ZA04	07:00 - 08:30	08:30 - 09:10	09:10 - 11:49					11:49 - 11:50		11:50 - 13:00
ZA06	07:00 - 09:00		09:00 - 11:50					11:50 - 11:52	11:52 - 12:00	12:00 - 13:00
ZA12	07:00 - 08:30	08:30 - 09:00	09:00 - 12:00				12:00 - 12:10	12:10 - 12:12	12:12 - 12:20	12:20 - 13:00
ZA11	07:00 - 08:30	08:30 - 09:00		09:00 - 11:00	11:00 - 11:15	11:15 - 11:50	11:50 - 12:00	12:00 - 12:02	12:02 - 12:10	12:10 - 13:00
Functionality allowed	View open/expired orders	Order entry/amendment/deletion	Order entry/amendment/deletion; automatic matching	Order entry/amendment/deletion; automatic matching	Order entry/amendment/deletion	Order entry/amendment/deletion; automatic matching	Order entry/amendment/deletion	Closing price publication; order deletion	Order entry, order modification (except price), order deletion	Order deletion; GTT orders are expired

#### EARLY CLOSE DAY - Off Book Trades

SEGMENT	TRADE REPORTING	Post Close
ZA01	08:00 - 13:00	13:00 - 13:05
ZA02		
ZA03		
ZA04		
ZA06		
ZA12		
ZA11		
Functionality allowed	Manage Off Book trades	

\*The JSE may amend these times

### 8.4.1.3 Futures Close Out Day

The trading sessions for a Futures Close Out<sup>1</sup> Day is reflected below.

**Schedule for instruments that will participate in the FCO Auction Call Session:**

#### FUTURES CLOSE OUT DAY - On Book Trades

#### SCHEDULE FOR INSTRUMENTS PARTICIPATING IN THE FCO AUCTION CALL SESSION - ALL OTHER INSTRUMENTS FOLLOW NORMAL DAY SCHEDULE

SEGMENT	START OF TRADING	OPENING AUCTION CALL	CONTINUOUS TRADING	CONTINUOUS TRADING 1	INTRADAY AUCTION CALL	FCO AUCTION CALL	CONTINUOUS TRADING 2	CLOSING AUCTION CALL	CLOSING PRICE PUBLICATION	CLOSING PRICE CROSS	POST CLOSE
ZA01	07:00 - 08:30	08:30 - 09:00		09:10 - 12:00		12:00 - 12:15	12:15 - 16:50	16:50 - 17:00	17:00 - 17:02	17:02 - 17:10	17:10 - 18:15
ZA02	07:00 - 08:30	08:30 - 09:00		09:10 - 12:00		12:00 - 12:15	12:15 - 16:50	16:50 - 17:00	17:00 - 17:02	17:02 - 17:10	17:10 - 18:15
ZA03	07:00 - 08:30	08:30 - 09:00		09:10 - 12:00		12:00 - 12:15	12:15 - 16:50	16:50 - 17:00	17:00 - 17:02	17:02 - 17:10	17:10 - 18:15
ZA04	07:00 - 08:30	08:30 - 09:10		09:10 - 12:00		12:00 - 12:15	12:15 - 16:50		16:49 - 16:50		16:50 - 18:15
ZA06	07:00 - 09:00			09:10 - 12:00		12:00 - 12:15	12:15 - 16:50		16:50 - 16:52	16:52 - 17:00	17:00 - 18:15
ZA11	07:00 - 08:30	08:30 - 09:00		09:00 - 12:00	12:00 - 12:15	12:00 - 12:15	12:15 - 16:50	16:50 - 17:00	17:00 - 17:02	17:02 - 17:10	17:10 - 18:15
ZA12	07:00 - 08:30	08:30 - 09:00	09:00 - 17:00					17:00 - 17:10	17:00 - 17:02	17:02 - 17:10	17:10 - 18:15
Functionality allowed	View open/expired orders	Order entry/amendment/deletion	Order entry/amendment/deletion; automatic matching	Order entry/amendment/deletion; automatic matching	Order entry/amendment/deletion	Order entry/amendment/deletion	Order entry/amendment/deletion; automatic matching	Order entry/amendment/deletion	Closing price publication; order deletion	Order entry, order modification (except price), order deletion	Order deletion; GTT orders are expired

#### FUTURES CLOSE OUT DAY - Off Book Trades

SEGMENT	TRADE REPORTING	Post Close
ZA01	08:00 - 18:15	18:15 - 18:20
ZA02		
ZA03		
ZA04		
ZA06		
ZA11		
ZA12		
Functionality allowed	Manage Off Book trades	

<sup>1</sup> Quarterly Futures Close Out will follow the FCO Auction Call Session while the Monthly FCO will follow the End of Day Closing Auction Call.

---

## 8.4.2 Start of Trading Session

This session will typically be the first session for an instrument following the successful start of day process.

### **Start / End Times:**

The Start and End times of this session be scheduled and will initiate automatically.

### **Executions:**

No automatic executions will take place during Start of Trading session

### **Order Management:**

- Traders will not be able to submit or amend orders during this session.
- Traders will be able to cancel orders during this session.
- The GTC/GTD orders, carried forward from the previous trading day (including unelected Stop and Stop Limit orders), will be the only orders in the order book.

### **Market Data**

The start of this session will be published through the market data gateways including any updates done to the Order Book by the JSE.

## 8.4.3 Opening Auction Call Session

The Opening Auction Call session will be scheduled immediately after the Start of Trading Session. The opening auction call will no longer be applicable to Trading segment ZA06 (Exchanged Traded Product).

### **Start / End Times:**

This session will have a scheduled Start and End Time.

### **Executions:**

- The orders accumulated during this session will be executed at the uncrossing based on the Volume Maximising algorithm following any Price Monitoring or Market Order Extensions.
- Any existing Iceberg orders will participate during the uncrossing of the Auction in their entirety i.e. the total visible and hidden portion of the Iceberg Order takes part in the determination of the auction price.

### **Order Management:**

- All orders accepted during this session will be added to the order book.
- Traders will be able to submit, cancel or amend orders during this session.
- Entry of new Pegged Hidden orders will not be allowed during this session
- Amendments to Pegged Hidden orders will not be allowed during this session.
- Existing Pegged Hidden orders will be parked and will not participate in the uncrossing of the auction.
- Limit or Market orders with IOC or FOK time qualifiers will not be accepted during this session.
- Valid Stop and Stop Limit orders (including those that are electable and those with the time qualifier IOC or FOK) will be stored in an unelected state until the end of the session at which point they may, if applicable, be elected.

- 
- The remainder, if any, of Market orders will expire following the uncrossing of the auction.
  - The remainder, if any, of OPG orders will expire following the uncrossing of the auction.
  - The remainder, if any, of GFA orders will be parked for the next auction.
  - GTT orders will not be expired during this session prior to the uncrossing.
  - The remainder, if any, of GTT orders whose expiry times have elapsed will expire following the uncrossing of the auction.
  - If the JSE manually invokes a different session then it is considered a session change and all OPG orders will expire.

**Market Data:**

- The start of this session will be published through the market data gateways.
- Order updates will be published through the market data gateways.
- Indicative Auction information will be published through the market data gateways.
- Trades executed at the uncrossing will be published through the market data gateways.
- Statistics updates will be published through the market data gateways.

**Price Monitoring and Market Order Extensions:**

The Opening Auction Call session may be followed by a series of Market Order and Price Monitoring Extensions. The number of and duration of these extensions is defined per Market Segment in each trading session.

#### **8.4.4 Continuous Trading Session**

**Start / End Times:**

The Start and End times of this session be scheduled and will initiate automatically.

**Executions:**

The System will continuously match incoming orders against those in the order book according to the price-visibility-time execution rules

**Order Management:**

- All orders accepted during this session will be added to the order book.
- Traders will be able to submit, cancel or amend orders during this session.
- Entry of Market, Limit, Stop, Stop Limit orders will be allowed during this session.
- Entry of Hidden orders will be allowed during this session.
- GTT orders will expire upon reaching their expiry time.
- Cross orders can only be submitted during this session.
- Traders will be able to submit GDX orders for the EOD Volume Auction

**Market Data:**

- The start of this session will be published through the market data gateways.
- Order updates will be published through the market data gateways.
- Trades will be published through the market data gateways.

- 
- Statistics updates will be published through the market data gateways.

### **Circuit Breakers**

Circuit Breakers will be applicable as configured for the applicable segment.

## **8.4.5 Volatility Auction Call Session (triggered)**

### **Start / End Times:**

This session will only trigger when an instruments' circuit breaker tolerance level has been breached.

Volatility Auction Call sessions last for a scheduled period of 5 minutes.

### **Executions:**

- The orders accumulated during this session will be executed at the uncrossing based on the Volume Maximising algorithm following any Price Monitoring or Market Order Extensions.
- Any existing Iceberg orders should participate during the uncrossing of the Auction in their entirety i.e. the total visible and hidden portion of the Iceberg Order takes part in the determination of the auction price

### **Order Management:**

- All orders accepted during this session will be added to the order book.
- Traders will be able to submit, cancel or amend orders during this session.
- Entry of Market, Limit, Stop, Stop Limit orders will be allowed during this session.
- Entry of Pegged Hidden orders will not be allowed during this session.
- Existing Pegged Hidden orders will be parked and will not participate in the uncrossing of the auction.
- Limit or Market orders with IOC or FOK time qualifiers will not be accepted during this session.
- Valid Stop and Stop Limit orders (including those that are electable and those with the time qualifier IOC or FOK) will be stored in an unelected state until the end of the session at which point they may, if applicable, be elected.
- Parked GFA orders if any will be injected into the order book at the start of this session.
- The remainder, if any, of Market orders will expire following the uncrossing of the auction.
- The remainder, if any, of GFA orders will be parked (for the next auction) if the applicable GFA Policy is "Multiple Auctions" else expired following the uncrossing of the auction.
- GTT orders will not be expired during this session prior to the uncrossing.
- The remainder, if any, of GTT orders whose expire times have elapsed will expire following the uncrossing of the auction
- Cross orders will not trigger a Volatility Auction Call Session

### **Market Data:**

- The start of this session will be published through the market data gateways.
- Order updates will be published through the market data gateways.
- Trades executed at the uncrossing will be published through the market data gateways.
- Statistics updates will be published through the market data gateways.



- 
- Indicative Auction information will be published through the market data gateways.

**Market Order Extensions:**

Volatility Auction Call session can be followed by a series of Market Order Extensions. The behaviour of the Market Order Extensions will be the same as for any other Auction Call session.

#### 8.4.6 Intraday Auction Call Session

**Start End Time:**

This session will have a scheduled Start and End Time and is applicable for ZA03 and ZA12.

**Executions:**

- The orders accumulated during this session will be executed based on the Volume Maximising algorithm following any Price Monitoring or Market Order Extensions.
- Any existing Iceberg orders should participate during the uncrossing of the Auction in their entirety i.e. the total visible and hidden portion of the Iceberg Order takes part in the determination of the auction price.

**Order Management:**

- All orders accepted during this session will be added to the order book.
- Traders will be able to submit, cancel or amend orders during this session.
- Entry of Market, Limit, Stop, Stop Limit orders will be allowed during this session.
- Entry of Pegged Hidden orders will not be allowed during this session.
- Existing Pegged Hidden orders will be parked and will not participate in the uncrossing of the auction.
- Amendments to Pegged Hidden orders will not be allowed during this session.
- Limit or Market orders with IOC or FOK time qualifiers will not be accepted during this session.
- Valid Stop and Stop Limit orders (including those that are electable and those with the time qualifier IOC or FOK) will be stored in an unelected state until the end of the session at which point they may, if applicable, be elected.
- Parked GFA and GFX orders if any will be injected into the order book at the start of this session.
- The remainder, if any, of Market orders will expire following the uncrossing of the auction.
- The remainder, if any of GFX orders will expire following the uncrossing of the auction.
- The remainder, if any, of GFA orders will be parked (for the next auction) if the applicable GFA Policy is "Multiple Auctions" else expired following the uncrossing of the auction.
- GTT orders will not be expired during this session prior to the uncrossing.
- The remainder, if any, of GTT orders whose expiry times have elapsed will expire following the uncrossing of the auction.
- If the JSE manually invokes a different session then it is considered a session change and all GFX orders will expire

---

**Market Data:**

- The start of this session will be published through the market data gateways.
- Order updates will be published through the market data gateways.
- Trades executed at the uncrossing will be published through the market data gateways,
- Statistics updates will be published through the market data gateways
- Indicative Auction information will be published through the market data gateways

**Price Monitoring and Market Order Extensions:**

- The Intraday Auction Call session may be followed by a series of Market Order and Price Monitoring Extensions, where applicable.
- The behaviour of the Market Order and Price Monitoring Extensions is the same as any other Auction Call session.

**8.4.7 Closing Auction Call Session (16:50\* - 17:00\*)**

*\*Times are an indication and may vary for different trading Segments.*

The Closing Auction Call session will be scheduled after the end of continuous trading. This session may also be triggered if a circuit breaker is breached within the Early Close.

**Start End Time:**

This session will have a scheduled Start and End Time.

However, the Closing Auction Call session could begin earlier (by the duration of the Early Close Threshold, which is determined by the JSE) if an instruments' circuit breaker is triggered. The Early Close Threshold duration has been configured to 10 minutes for both JSE and NSX markets. If the Early Close Threshold period is triggered for an instrument, the Closing Auction Call session will then begin 10 minutes earlier but the session will end at the scheduled time. The closing auction call will no longer be applicable to Trading segment ZA06 (Exchanged Traded Product).

**Executions:**

- The orders accumulated during this session will be executed based on the Volume Maximising algorithm following any Price Monitoring or Market Order Extensions.
- Any existing Iceberg orders should participate during the uncrossing of the Auction in their entirety i.e. the total visible and hidden portion of the Iceberg Order takes part in the determination of the auction price.

**Order Management:**

- All orders accepted during this session will be added to the order book.
- Traders will be able to submit, cancel or amend orders during this session.
- Entry of Market, Limit, Stop, Stop Limit orders will be allowed during this session.
- Entry of Pegged Hidden orders will not be allowed during this session.

- 
- Existing Pegged Hidden orders will be parked and will not participate in the uncrossing of the auction.
  - Amendments to Pegged Hidden orders will not be allowed during this session.
  - Limit or Market orders with IOC or FOK time qualifiers will not be accepted during this session.
  - Valid Stop and Stop Limit orders (including those with the time qualifier IOC or FOK) will be stored in an unelected state until the end of the uncrossing at which point they will be expired.
  - Parked GFA and ATC orders if any will be injected into the order book at the start of this session.
  - GFX orders can be entered at any time during the day, and they are parked and injected in the Intra Day auction. GFX orders entered prior to the Intraday Auction will expire at the end of the uncrossing. GFX orders entered after the Intraday Auction will expire at Market End.
  - The remainder, if any, of Market orders will expire following the uncrossing of the auction.
  - The remainder, if any, of ATC orders will expire following the uncrossing of the auction.
  - The remainder, if any, of GFA orders will be parked and expired at Market End if the applicable GFA Policy is "Multiple Auctions" else expired following the uncrossing of the auction.
  - GTT orders will not be expired during this session prior to the uncrossing.
  - The remainder, if any, of GTT orders whose expire times have elapsed will expire following the uncrossing of the auction.

If the JSE manually invokes a different session then it is considered a session change and all ATC orders will expire.

**Market Data:**

- The start of this session will be published through the market data gateways.
- Order updates will be published through the market data gateways.
- Trades executed at the uncrossing will be published through the market data gateways.
- Statistics updates will be published through the market data gateways.
- Indicative Auction information will be published through the market data gateways.

**Price Monitoring and Market Order Extensions:**

- The Closing Auction Call session may be followed by a series of Market Order and Price Monitoring Extensions, where applicable.
- The behaviour of the Market Order and Price Monitoring Extensions is the same as any other Auction Call session.

#### **8.4.8 Closing Price Publication Session (\*)**

\* times may vary per segment please refer to [section 8.4.1](#)

**Start Time:**

- 
- The Closing Price Publication (CPP) session will be scheduled immediately after the Closing Auction Call session for all trading segments or at a specific time for segments that do not have a Closing Auction session. Please refer to section 8.4.1 for details.
  - This session will have a duration of 2 minutes

**Executions:**

- No executions will take place during the CPP session.

**Order Management:**

- Traders will be able to cancel orders during this session.
- Any cancellation request during the CPP session for parked orders or unelected stop and stop limit orders are accepted and the relevant orders are cancelled immediately. If the Primary Closing Price Convention or the Secondary Closing Price Convention of a trading Segment is set to "Mid-Point" then order cancellations will not be allowed during this session.
- GTT orders entered in earlier sessions or during the CPP session may get expired if their expiration time is reached.
- Orders with TIFs ATC, OPG, GFA, GFX, IOC and FOK are rejected during this session.
- All amendment requests for orders with TIFs DAY, GTD, GTC, GTT or CPX will be rejected by the System.
- GTT orders will expire upon reaching their expiry time.

**Market Data:**

- The start of this session will be published through the market data gateways.
- Order book updates will be published through the market data gateways.
- Statistics updates will be published through the market data gateways.
- Closing prices computed will be published at the start of this session for the Normal Order Book.

#### **8.4.9 Closing Price Cross Session (\*)**

\* times may vary per segment please refer to [section 8.4.1](#)

**Start End Time:**

- The Closing Price Cross (CPX) session will be scheduled after the Closing Price Publication session.
- This session will have a duration of 5 minutes

**Executions:**

- Trading will only take place at the Closing Price that was published during the Closing Price Publication session.

**Order Management:**

**Existing Orders**

- Existing orders with DAY, CPX, GTT, GTC and GTD TIFs with order types Market and Limit having an equal or better price than the published Closing Price which were parked during Closing Price Publication (CPP) session are injected onto the order book at the start

---

of the Closing Price Cross (CPX) session. Limit orders having a price equal to the published Closing Price are injected onto the order book without any change. Limit orders with better prices are re-priced to the Closing Price before they are injected. *E.g. on the Buy side of the order book, if the published closing price is 100 ZAC and the CPX order price is 101 ZAC then the CPX order is re-priced to 100 and will participate in the CPX session.*

- Orders with TIF of CPX, with worse prices than the Published Closing Price, which were entered and parked during CPP, are expired at the beginning of the CPX session. GTC and GTD orders with worse prices than the Closing Price will not participate in the CPX session, but could enter the order book on the next trading day if the expiry has not been reached.
- CPX limit orders with prices better than the published closing price will be amended to be equal to the closing price. This amendment will not cause those orders to lose time priority.
- All orders, on entering the order book, will aggress the order book one by one in time priority (i.e. based on the time they were submitted). They are executed ONLY at the published Closing Price with eligible contra orders. All CPX orders, including the CPX market orders, get a lower priority than orders that were accepted onto the order book prior to the start of the CPX session.
- Pegged Hidden Orders will not participate in this session as the filtering algorithm, normally applied to Pegged Hidden Orders during the Continuous trading session, is not run during the CPX session. This means that Pegged Hidden Orders will only execute if the MES constraint can be fully satisfied by a single new order or injected contra order in the book.

#### **New Orders**

New orders entered during the CPX session will be accepted by the system according to the following rules:

- GFA, GFX, OPG and ATC orders submitted during the CPX session will be rejected.
- If the new order is a market order with a valid TIF type, it will be eligible to participate in the CPX session.
- If the new order is a limit order with a valid TIF type with a limit price equal to or better than the published Closing Price, it will be eligible to participate in the CPX session. This will include new JSE Iceberg orders submitted during the CPX session.
- If the new order is a limit order with a valid TIF type with a limit price that is worse than the published Closing Price, it will be rejected by the system.
- If the new order is a stop/stop limit order with a valid TIF type, it will be rejected.
- During the CPX session, new CPX market orders will be accepted onto the order book. Remainder of unexecuted CPX market orders submitted during the CPX session will be converted to limit orders at the closing price.
- If there are no or insufficient orders on the contra side to match with the new order for any market order that enters the CPX session, the unexecuted quantity will be expired.

#### **Order Expiry**

- Unexecuted orders that took part in the CPX session will not be carried over to the next day unless they are GTD/GTC orders.
- At the end of the CPX session, any stop limit order with GTD/GTC TIFs that was re-priced will be priced back to its original price. These orders will be carried forward to the next trading day with their original price.
- Unexecuted CPX orders that took part in the session will not be carried forward to the next day. They will be expired at the end of the session.

#### **Order Amendments**

- 
- Once the CPX session has begun no price amendments can be done to either CPX or non-CPX orders that have been eligible for the CPX session. Any other amendments can be done to both CPX and non-CPX orders that have been eligible for the CPX session.

Amendments can be done to any non-CPX orders in the order book that are ineligible for the CPX session, in the following manner:

- If the price of an ineligible order is amended to be equal to the published closing price, it will become eligible for the CPX session.
- If the price of an ineligible order is amended to either a better or worse price than the published closing price, the system will reject the price amendment request.
- Any orders taking part in the CPX session can be cancelled during the session.
- No amendments can be done on stop/stop limit orders that are still in an unelected state.
- Amendments and cancellation taken place with respect to all orders during this session will be disseminated via the Market Data Gateways.

**Market Data:**

- The start of this session will be published through the market data gateways.
- Order updates will be published through the market data gateways.
- Statistics updates will be published through the market data gateways.
- Trades will be published through the market data gateways.

#### 8.4.11 Post Close Session

**On Book Trades: (17:15\* - 18:15\*)**

**Start End Time:**

- The Post Close session will be scheduled immediately after the Closing Price Publication Session.
- This session will have a scheduled Start and End Time.

**Executions:**

No executions will take place during the post close session.

**Order Management:**

- Traders will be able to cancel orders during this session.
- Traders will not be able to submit or amend orders during this session.
- All unexecuted GTT orders will be expired at the start of this session.

**Market Data:**

- The start of this session will be published through the market data gateways.
- Order updates will be published through the market data gateways.

**Off Book Trades: (18:15\* - 18:20\*)**

Block Trades that are delayed such that they may result in being published after market end time (this relates to the time that End-Of-Day processes start for the day), will be published at

---

the start of the Post Close session.

#### **8.4.12 Trade Reporting Session (08:00 - 18:15)**

Off book trades can be submitted / cancelled during the Start and End times specified for the Trade Reporting Session regardless of the session that a market/segment/instrument may be in. Trades and statistics, where applicable, will be published through the market data gateways.

#### **8.4.13 Trade Reporting Halt Session (manually invoked)**

A Halt to a Trade Reporting Session can be invoked by the JSE.

#### **8.4.14 Halt Session (manually invoked)**

##### **Start End Time:**

This session will be manually triggered by Market Operations Users. A halt may be triggered for the Market, Segment or Instrument.

##### **Executions:**

- No executions will take place during the Halt session.
- The orders in the order book, during continuous trading, if any, will remain in the System without being expired.
- If the instrument or the market is halted during an auction session, market orders will immediately be expired at the start of the Halt session and GFA orders will be parked.

##### **Order Management:**

- Traders will be able to cancel orders during this session.
- Traders will not be able to submit or amend orders during this session.
- Traders will not be able to make any client reference amendments as this is an amendment to an order.
- GTT orders will expire upon reaching their expiry time.

##### **Market Data:**

- Upon initiating a halt, the system will disseminate the halt and the reason via the market data gateways.
- Order updates will be published to the market through the market data gateways.

#### **8.4.15 Halt and Close Session (with Closing Price) (manually invoked)**

The behaviour of the Halt and Close Session will be the same as the Halt Session except for the following:

- On invoking the Halt and Close session the calculation of closing prices will be performed according to the same criterion which is used for the calculation of closing price in the normal circumstances for the instrument.

- 
- The actual session is a Halt Session and the market is notified that the session change is to a Halt Session.

#### **8.4.16 Pause Session (manually invoked)**

##### **Start End Times:**

This session will be manually triggered by the JSE.

##### **Executions:**

No executions will take place during the Pause session.

##### **Order Management:**

- Traders will be able to submit, amend or cancel orders during this session.
- Entry of Market, Limit, Stop, Stop Limit orders will be allowed during this session.
- Entry of new Hidden Orders is not allowed.
- Limit or Market orders with IOC or FOK time qualifiers will not be accepted during this session.
- Valid Stop and Stop Limit orders (including those with the time qualifier IOC or FOK) will be stored in an unelected state.
- GTT orders will expire upon reaching their expiry time.
- Market orders will be expired at the end of the Pause session.

##### **Market Data:**

- Upon initiating a Pause session, the system will disseminate the Pause and the reason via the market data gateways.
- Order updates will be published to the market through the market data gateways.

#### **8.4.17 Re-Opening Auction Call Session (manually invoked)**

##### **Start End Times:**

The JSE may manually invoke the Re-Opening Auction Call session when resuming from a manual trading halt or a trading pause. A Re-Opening Auction Call session may also be automatically triggered when the JSE changes an instrument status from Suspended to Active.

##### **Executions:**

The orders accumulated during this session will be executed at the uncrossing based on the Volume Maximising algorithm following any Price Monitoring or Market Order Extensions.

Any existing Iceberg orders should participate during the uncrossing of the Auction in their entirety i.e. the total visible and hidden portion of the Iceberg Order takes part in the determination of the auction price.

##### **Order Management:**

- All orders accepted during this session will be added to the order book.
- Traders will be able to submit, cancel or amend orders during this session.
- Entry of Market, Limit, Stop, Stop Limit orders will be allowed during this session.
- Entry of Pegged Hidden orders will not be allowed during this session.
- Existing Pegged Hidden orders will be parked and will not participate in the uncrossing of the auction.



- 
- Amendments to Pegged Hidden orders will not be allowed during this session.
  - Limit and Market orders with OPG, IOC or FOK time qualifiers will not be accepted during this session.
  - Valid Stop and Stop Limit orders (including those that are electable and those with the time qualifier IOC or FOK) will be stored in an unelected state until the end of the session at which point they may, if applicable, be elected.
  - Parked GFA orders if any will be injected into the order book at the start of this session.
  - The remainder, if any, of Market orders will expire following the uncrossing of the auction.
  - The remainder, if any, of GFA orders will be parked (for the next auction) if the applicable GFA Policy is "Multiple Auctions" else expired following the uncrossing of the auction.
  - GTT orders will not be expired during this session prior to the uncrossing.
  - The remainder, if any, of GTT orders whose expire times have elapsed will expire following the uncrossing of the auction.

**Market Data:**

- The start of this session will be published through the market data gateways.
- Order updates will be published through the market data gateways.
- Trades executed at the uncrossing will be published through the market data gateways,
- Statistics updates will be published through the market data gateways
- Indicative Auction information will be published through the market data gateways

**Price Monitoring and Market Order Extensions:**

- Re-Opening Auction Call session can be followed by a series of Market Order and Price Monitoring Extensions.
- The behaviour of the Market Order and Price Monitoring Extensions are the same as the Re-Opening Auction Call session.

#### **8.4.18 Futures Close Out Auction Call Session (12:00 - 12:15)**

The Futures Close Out session will only be applicable on Futures Close Out Days as defined in the Calendar.

**Note:** This will be applicable only on Quarterly Futures Close Out days.

This will be a normal Auction Call trading session scheduled on Futures Close Out Days.

**Start End Times:**

This session will have a scheduled Start and End Time that will only trigger for the instruments that have been flagged to participate in the Futures Close Out day.

**Executions:**

The orders accumulated during this session will be executed at the uncrossing based on the Volume Maximising algorithm following any Price Monitoring or Market Order Extensions.

-Pegged Hidden orders should participate during the uncrossing of the Auction in their entirety i.e. the total visible and hidden portion of the Iceberg Order takes part in the determination of the auction price.

**Order Management:**

- 
- All orders accepted during this session will be added to the order book.
  - Traders will be able to submit, cancel or amend orders during this session.
  - Entry of Market, Limit, Stop, Stop Limit orders will be allowed during this session.
  - Entry of Pegged Hidden orders will not be allowed during this session.
  - Existing Pegged Hidden orders will be parked and will not participate in the uncrossing of the auction.
  - Amendments to Pegged Hidden orders will not be allowed during this session.
  - Limit and Market orders with OPG, IOC or FOK time qualifiers will not be accepted during this session.
  - Valid Stop and Stop Limit orders (including those that are electable and those with the time qualifier IOC or FOK) will be stored in an unelected state until the end of the session at which point they may, if applicable, be elected.
  - Parked GFA orders if any will be injected into the order book at the start of this session.
  - The remainder, if any, of Market orders will expire following the uncrossing of the auction.
  - The remainder, if any, of GFA orders will be parked (for the next auction) if the applicable GFA Policy is "Multiple Auctions" else expired following the uncrossing of the auction.
  - GTT orders will not be expired during this session prior to the uncrossing.
  - The remainder, if any, of GTT orders whose expire times have elapsed will expire following the uncrossing of the auction.

**Market Data:**

- The start of this session will be published through the market data gateways.
- Order updates will be published through the market data gateways.
- Trades executed at the uncrossing will be published through the market data gateways,
- Statistics updates will be published through the market data gateways
- Indicative Auction information will be published through the market data gateways

**Price Monitoring and Market Order Extensions (triggered)**

- Futures Close Out Auction Call session may be followed by a one Market Order and two Price Monitoring Extension.
- The behaviour of the Market Order and Price Monitoring Extensions are the same as the Intraday Auction Call session.

**Determination of Futures Close Out Settlement Price**

The FCO settlement price will be the Uncrossing Price at the end of the auction – if the instrument does not trade at the end of the auction, the FCO Settlement price will be the last AT/UT prior to the FCO Auction Call session. If the instrument did not trade prior to the FCO auction, the FCO Settlement price will be the previous day's closing price.

Below is a summary of the Trading Sessions and the order validity combinations:

**TRADING SESSIONS AND ORDER VALIDITY COMBINATIONS**

- Orders will be accepted
- Orders will be rejected
- Orders will be accepted and parked
- Orders accepted and either execute or expire
- Orders will be carried over from the previous day

SESSION NAME	ORDER TYPE / TIME IN FORCE																	
	OPG	ATC	IOC	FOK	GTC	GTD	GTT	GFA	GFX	DAY	CPX	GDX	MARKET	LIMIT	STOP / STOP LIMIT	CROSS ORDER	PEGGED HIDDEN	PEGGED HIDDEN LIMIT
Start of Trading	Red	Red	Red	Red	Green	Green	Red	Red	Red	Red	Red	Grey	Red	Red	Red	Red	Red	Red
Opening Auction Call	Green	Yellow	Red	Red	Green	Green	Green	Green	Yellow	Green	Yellow	Grey	Green	Green	Yellow	Red	Green	Green
Continuous Trading	Red	Yellow	Blue	Blue	Green	Green	Green	Yellow	Green	Green	Green	Grey	Blue	Green	Green	Green	Green	Green
Volatility Auction Call	Red	Yellow	Red	Red	Green	Green	Green	Green	Yellow	Green	Yellow	Grey	Green	Green	Yellow	Red	Green	Green
Intra-day Auction Call	Red	Yellow	Red	Red	Green	Green	Green	Green	Green	Green	Yellow	Grey	Green	Green	Yellow	Red	Green	Green
Closing Auction Call	Red	Green	Red	Red	Green	Green	Green	Green	Yellow	Green	Yellow	Grey	Green	Green	Yellow	Red	Red	Red
Closing Price Publication	Red	Red	Red	Red	Red	Red	Red	Red	Red	Red	Red	Grey	Red	Red	Red	Red	Red	Red
Closing Price Cross	Red	Red	Red	Red	Green	Green	Green	Red	Red	Green	Green	Grey	Green	Green	Red	Red	Red	Red
EOD Volume Auction Call	Red	Red	Red	Red	Green	Green	Green	Red	Red	Green	Green	Grey	Green	Green	Red	Red	Red	Green
Post Close	Red	Red	Red	Red	Red	Red	Red	Red	Red	Red	Red	Grey	Red	Red	Red	Red	Red	Red
Halt	Red	Red	Red	Red	Red	Red	Red	Red	Red	Red	Red	Grey	Red	Red	Red	Red	Red	Red
Halt and Close	Red	Red	Red	Red	Red	Red	Red	Red	Red	Red	Red	Grey	Red	Red	Red	Red	Red	Red
Pause	Red	Yellow	Red	Red	Green	Green	Green	Yellow	Yellow	Green	Yellow	Grey	Green	Green	Yellow	Red	Red	Red
Re-opening Auction Call	Red	Yellow	Red	Red	Green	Green	Green	Green	Green	Green	Yellow	Grey	Green	Green	Yellow	Red	Green	Green
FCO Auction Call	Red	Yellow	Red	Red	Green	Green	Green	Green	Green	Green	Yellow	Grey	Green	Green	Yellow	Red	Green	Green

\* Orders can participate if the Execution Instruction has been provided  
 \*\* Only existing pegged orders can participate in EOD Volume Auction  
 \*\*\* Except for IOC and FOK Stop and Stop Limit Orders, which will be stored in the Order Book until the stop price is triggered and the order is elected.  
 \*\*\*\* Self-match prevention will apply

---

## 8.5 Static and Dynamic Reference Price

There are two Reference prices used the Static Reference Price and the Dynamic Reference Price:

### 8.5.1 Static Reference Price

At the beginning of the day the Static Reference Price for an instrument will be its Previous Close. The Static Reference Price will be updated after each auction (Opening, Re-Opening, Intraday or Volatility); and

If an auction call Session is triggered but an auction uncrossing does not take place (e.g. Order book not locked/crossed), the Static Reference Price will be updated by the first trade after the auction and it will be the price of the first trade.

Static reference price will not be updated by an Off Book trade.

Note: Cross order executions (XT) will not update the Static Reference Price

### 8.5.2 Dynamic Reference Price

At the beginning of the trading day, the Dynamic Reference Price for an instrument will be its Previous Close.

- If an uncrossing happens at the end of the Opening Auction, then the Dynamic reference price will be updated with the Opening auction uncrossing trade price.
- If an uncrossing does not happen at the end of the Opening Auction, then the first automatic trade of the day will update the Dynamic reference prices.
- If an auction was triggered and an uncrossing happens at the end of any auction call session (Volatility, Intraday or Re-Opening Auction), then the Dynamic Reference Price will be updated with the auction uncrossing trade price.
- If an auction was triggered but an uncrossing does not happen at the end of any of the auction call sessions during the day (Volatility, Intraday or Re-Opening Auction), then the first automatic trade after the auction will update the Dynamic reference price.
- Dynamic reference price will not be updated by an Off book trade.

The Dynamic Reference Price will continue to be updated with the automatic trades happening during the day.

Note: Cross order executions (XT) will not update the Dynamic Reference Price

## 8.6 Order Book Matching Priority and Executions

### 8.6.1 Central Order Book

The central order book is an order-matching facility where members participate on equal terms, competing for execution on the basis of strict price-visibility-time priority. Any hidden order at a better price will take priority and visible orders will take priority over hidden orders if they are placed at the same price.

### 8.6.2 Volume Maximising Auction Algorithm

The Volume Maximising Auction Algorithm is generally used in all the auctions such as the opening Auction, Closing Auction, Volatility Auction, Intra-day Auction and re-opening Auction.

---

### 8.6.2.1 Order Book is locked/crossed

Each price point, for which there are orders in the order book, will be considered and the number of shares that would be executed if the auction uncrossing took place at each price point will be calculated.

There are four steps in the Algorithm:

#### **1<sup>st</sup> Step:**

The auction price will be the price at which the largest number of shares can be executed i.e. the price at which the volume is maximized.

#### **2<sup>nd</sup> Step:**

If the volume is maximized at multiple prices then the auction uncrossing price will be the price at which the Order Imbalance is minimized.

#### **3<sup>rd</sup> Step:**

If the Order Imbalance is minimized at multiple prices then the concept of Market Pressure will be used.

- In the 2<sup>nd</sup> step of the Volume Maximising Auction Algorithm, if all the prices at which the Order Imbalance is minimized have a buy imbalance, then the highest price will be the auction price. (An Order Imbalance on the buy side means there will be a remaining quantity on the buy side; this remaining buy pressure is likely to cause the price to rise after the auction; hence the highest price is taken).
- In the 2<sup>nd</sup> step of the Volume Maximising Auction Algorithm, if all the price points at which the Order Imbalance is minimized has a sell imbalance, then the lowest price will be the auction price (an Order Imbalance on the sell side means there will be a remaining quantity on the sell side; this remaining sell pressure is likely to cause the price to fall after the auction; hence the lowest price is taken).
- In the 2<sup>nd</sup> step of the Volume Maximising Auction Algorithm, if the prices at which the Order Imbalance is minimized have buy and sell imbalances, then the highest price out of the prices with buy imbalances and lowest price out of the prices with sell imbalances will be chosen.

Order Imbalance (Order Surplus) means:

The Order Imbalance at a particular price will be the difference between the following two quantities:

- a) The aggregate quantity of all the Market Buy Orders and all the Limit Buy Orders with prices equal to or greater than the price being considered.
- b) The aggregate quantity of all the Market Sell Orders and all the Limit Sell Orders with prices equal to or less than the price being considered.

#### **4<sup>th</sup> Step:**

If step 3 resulted in two prices then the auction uncrossing price is determined as:

- If the Dynamic Reference Price is equal or greater than the highest price, then the highest price is chosen as the auction uncrossing price.
- If the Dynamic Reference Price is equal or less than the lowest price, then the lowest price is chosen as the auction uncrossing price.
- If the Dynamic Reference Price is in between the two prices, then the Dynamic Reference Price is chosen as the auction uncrossing price.

### 8.6.2.2 Order Book contains only Market Orders (on both sides)

The Auction price will be the Dynamic Reference Price. If a Dynamic Reference Price is not available and if there are only Market Orders available for the first volume maximizing auction then the auction uncrossing will not be carried out; the instrument will move to

---

the next trading session and all Market Orders will expire. There will also be no publication of Indicative Auction Information during the auction.

#### 8.6.2.3 **Uncrossing of the Auction**

The orders that are executable at the selected auction uncrossing price will first be identified. Then the side in the order book with the Order Imbalance will be identified.

The contra side of the side with the Order Imbalance will be the aggressive side where as the side with the Order Imbalance will be the passive side. If there is no Order Imbalance, then the buy side will be the aggressive side.

The orders with the highest priority on the aggressive side will be executed against the total quantity (that is, visible and hidden) of the orders on the passive side in terms of their Price-Visibility-Time priority in the order book.

The executions will be continued until all the executable orders on the aggressive side are fully filled. All executions performed during an auction uncrossing will take place at the auction price and will be published as a single trade for the purposes of market data. Individual execution reports and trades will be sent to the individual firms and the downstream system.

The remaining Market Orders in the order book will be expired after the auction is performed.

#### 8.6.2.4 **Order Book is not locked/crossed**

If the order book is not locked or crossed and there are no Market Orders then an auction cannot be performed. Hence the instrument will move to the next trading session.

### 8.6.3 **Auction Trading**

#### 8.6.3.1 **Randomised Auction Uncrossing**

The uncrossing will occur at a random time after the scheduled end time of the session.

The **Maximum Random Duration** has been configured to 60 seconds.

If there is an auction extension applicable, the System will first attempt to uncross during the random 60 second period, after which the appropriate auction extension will trigger.

If there are multiple auction extensions applicable, there will be a random 60 second period between each extension, until there are no more extensions available. The uncrossing will then occur during the random 60 second period, after the end of the last auction extension.

**Example:** Taking the latest possible random time (i.e. the 60<sup>th</sup> second) of the Maximum Random Duration:

Start Time	End Time	Description
12:00:00	12:15:00	FCO Auction Call Session
12:15:00	12:16:00	<b>Maximum Random Duration (60s)</b> During this time, executions will trigger at a random time. Market Order Extension (MOE) was triggered at 12:16:00
12:16:00	12:18:00	MOE Duration- 2 minutes
12:18:00	12:19:00	<b>Maximum Random Duration (60s)</b> During this time, executions will trigger at a random time. Price Monitoring Extension (PME) was triggered at 12:18:00
12:18:00	12:22:00	PME Duration- 4 minutes
12:22:00	12:23:00	<b>Maximum Random Duration (60s)</b> During this time, executions will trigger at a random time. Price Monitoring Extension (PME) was triggered at 12:23:00
12:23:00	12:27:00	PME Duration- 4 minutes
12:27:00	12:28:00	<b>Maximum Random Duration (60s)</b> During this time, executions will trigger at a random time.
<b>Executions could take place between 12:27:00 and 12:28:00</b>		

Taking the **earliest possible random time (i.e. the 1<sup>st</sup> second) of the Maximum Random Duration:**

Start Time	End Time	Description
12:00:00	12:15:00	FCO Auction Call Session
12:15:00	12:15:01	<b>Maximum Random Duration (60s)</b> During this time, executions will trigger at a random time. Market Order Extension (MOE) was triggered at 12:15:01
12:15:01	12:17:01	MOE Duration- 2 minutes
12:17:01	12:17:02	<b>Maximum Random Duration (60s)</b> During this time, executions will trigger at a random time. Price Monitoring Extension (PME) was triggered at 12:17:02
12:17:02	12:21:02	PME Duration- 4 minutes
12:21:02	12:21:03	<b>Maximum Random Duration (60s)</b> During this time, executions will trigger at a random time. Price Monitoring Extension (PME) was triggered at 12:21:03
12:21:03	12:25:03	PME Duration- 4 minutes
12:25:03	12:25:04	<b>Maximum Random Duration (60s)</b> During this time, executions will trigger at a random time.
<b>Executions could take place between 12:25:03 and 12:25:04</b>		

Therefore, in this scenario, executions could take place anywhere between 12:25:03 and 12:27:00.

The Volume Maximising Auction Algorithm is generally used in all the auctions such as Opening Auction, Closing Auction, Volatility Auction, Intraday Auction and Re-Opening Auction.

#### 8.6.3.2 Indicative Auction Information

Prior to an auction uncrossing the below mentioned Indicative Auction Information will be disseminated during the auction call session:

- Indicative auction price (if any)
- Executable volume (if any) at the indicative auction price.

Indicative Auction Information will be computed and disseminated on each order book update (i.e. order entry, amendment, cancellation or expiration).

---

The Indicative Auction Information is calculated based on the Volume Maximising Auction Algorithm which is used to determine the auction uncrossing price; all the order quantities (visible and hidden) will be considered for Indicative Auction Information calculation.

If the Dynamic Reference Price is selected as the Indicative Auction Price at the 4th step of the Volume Maximising Auction Algorithm, then only the indicative auction price will be disseminated, the executable quantity will not.

## 8.6.4 Continuous Trading

### 8.6.4.1 Order Book Priority in Continuous Trading

Orders are matched on Price-Visibility-Time Basis. Within a price point, the visible orders have the highest priority over any Hidden orders. Visible orders are executed based on their time priority within the price point.

- As per Price-Visibility-Time priority, the buy order having the highest price will have the highest priority in the order book.
- As per Price-Visibility-Time priority, the sell order having the lowest price will have the highest priority in the order book.

When a parked order (Stop, Stop Limit) is elected into the order book, the time priority is considered based on the order election time not based on the original submission time of the order. The elected time of the Stop / MIT orders will be stamped on the entry time field.

### 8.6.4.2 Executions Including Pegged Hidden Orders

#### Incoming / Aggressing Order = Pegged Order

- The system will first check if the incoming pegged order will be in an inactive or an active state. A pegged order that has not breached the hard limit will be considered as an active pegged order. The hard limit should be considered breached for a:
  - a) Buy pegged order, pegged to the mid, if the mid-price  $\geq$  hard limit price of the order
  - b) Buy pegged order, pegged to the bid, if the best visible bid price  $\geq$  hard limit price of the order
  - c) Sell pegged orders, pegged to the mid, if the mid-price, if mid-price  $\leq$  hard limit price of the order
  - d) Sell pegged orders, pegged to the offer, if the best visible offer price  $\leq$  hard limit price of the order
- An aggressing pegged order that has breached the hard limit should be added to the book without any executions in an inactive state.
- If the order is in an active state, the aggressing pegged order will be executed based on the following execution policy.
  - a) The execution of the pegged order will take into account the MES specified on the order and the MES specified in the resting pegged orders.
  - b) The MES specified in the aggressing pegged will be satisfied in a single system (atomic) transaction not in each and every trade execution within the transaction.
  - c) Passive pegged orders will be stepped over during execution if the MES constraint cannot be met.



- 
- d) Passive pegged orders in an inactive state will not be considered for execution.
  - e) The trade price will be the price of the passive order and Price Improvement Logic will be applicable for Pegged orders pegged to best bid or best offer
  - f) The system will check if the remaining quantity is less than the MES, prior to adding the remaining quantity of the aggressing order to the book after going through all marketable orders.
  - g) If the remaining quantity is less than the MES, the incoming pegged order will be expired. If not the remaining quantity will be added to the book.
  - h) After an execution if the remaining quantity of the passive pegged order is less than the MES, the passive pegged order will be expired.

If the pegged order is entered and deemed inactive by the system due to a hard limit being breached then the pegged order will be added to the book without any executions.

#### **Incoming / Aggressing Order = Visible Order**

- When the price of the incoming aggressing order is better than the visible best bid(buy order) or Offer (sell order), the aggressing visible order will first traverse the contra side of the pegged order container. (Only if there are pegged orders in the contra side)
- The incoming order will execute against each resting order in the pegged order container taking into account the MES size of the resting pegged orders and the time priority and the pegged price.
- If a Pegged Order is partially filled and the remaining quantity is less than the MES, the pegged order will expire.
- Pegged orders in an inactive state will not be considered.
- Once the incoming order has gone through all the marketable pegged orders, the remaining quantity (if available) of the incoming order will either;
  - a) Move to the main container and continue with executions (if applicable)
  - b) Added to the main order book
  - c) Expired based on the order type or the time in force

The trade price will be the price of the passive order and price improvement logic will be applicable for pegged orders pegged to best bid or best offer.

#### **8.6.4.3 Pegged Order Re-evaluation**

- Pegged order container will be re-evaluated at time intervals as specified in the trading parameter 'Re-evaluation Interval (sec)'.
- However, if the 'Re-evaluation Interval (sec)' parameter at the Trading Parameter level is set to zero then the pegged order container will be re-evaluated when there is a change to the mid of visible BBO. The mid of visible BBO change can occur due to the following reasons: (Please note there will be a latency impact during pegged order re-evaluation)
  - a) A new order creates a new visible BBO
  - b) An order amendment creates a new visible BBO
  - c) An order cancellation/expiration creates a new visible BBO
  - d) An auction creates a new visible BBO (at the start of the continuous trading session)
  - e) An aggressive order executes against passive orders and creates a new visible BBO
- Pegged order re-evaluation logic will be as follows:
  - a) The system will first move to the buy side of the pegged order container and aggress each buy pegged order one by one. (The aggressing pegged order will execute as per the logic specified in the section 8.6.4.2 above)

- 
- b) Once the systems runs through all orders in the buy side of pegged order container, it will move to the sell side of pegged order container and aggress each sell pegged order one by one.
- During the re-evaluation inactive pegged orders (buy or sell) should not be considered for aggression as well as for execution.
  - During pegged order re-evaluation “is aggressor” field will be set to ‘No’ for both aggressing and passive pegged orders.
  - Existing volatility auction behaviour will be applicable if a circuit breaker is triggered due to a pegged order re-evaluation.

#### 8.6.4.4 Price Improvement Logic

- 8.6.4.4.1 The value for the number of ticks by which the price is to be improved will be set at a half tick i.e. 0.5.
- 8.6.4.4.2 If the incoming buy order (visible or pegged) executes with passive sell pegged order pegged to the offer, the execution price will be best visible offer minus the value specified in the price improvement tick.
- 8.6.4.4.3 If the incoming sell order (visible or pegged) executes with passive buy pegged order pegged to the bid, the execution price will be best visible bid plus the value specified in the price improvement tick.
- 8.6.4.4.4 This will ensure that the pegged orders will only execute within the visible BBO spread

## 8.6.5 Circuit Breakers

Circuit breaker tolerance is defined as a percentage in relation to the Static Reference Price and / or Dynamic Reference Price. If the difference between the price of the next trade and the Static Reference Price or Dynamic Reference Price is equal or greater than that permitted by the circuit breaker tolerance defined for the relevant session the instrument will automatically be moved into a Volatility Auction Call session.

### Circuit Breaker Segments

Circuit breaker tolerances are defined at a trading session level. The relevant percentages have been defined for the JSE market in the table below.

1. The cells highlighted in yellow represent new Circuit Breakers introduced per trading session and segment.
2. The unshaded cells represent current circuit breakers (these will remain unchanged).
3. Cells with '*N/A*' are segments that do not apply Circuit Breakers in that particular trading session.

Trading Sessions	ZA01		ZA02		ZA03		ZA04		ZA06	
	Static Circuit Breaker	Dynamic Circuit Breaker	Static Circuit Breaker	Dynamic Circuit Breaker	Static Circuit Breaker	Dynamic Circuit Breaker	Static Circuit Breaker	Dynamic Circuit Breaker	Static Circuit Breaker	Dynamic Circuit Breaker
Opening Auction Call	8%	6%	20%	10%	50%	25%	70%	50%	20%	8%
Continuous Trading	10%	3%	15%	5%	50%	25%	N/A	N/A	15%	5%
Intraday Auction Call	N/A		N/A		50%	25%	N/A		N/A	
Closing Auction Call	4%	2%	10%	5%	50%	25%	N/A		20%	8%
FCO Auction Call	15%	2%	30%	4%	N/A		N/A		30%	4%
Re-Opening Auction Call*	8%	6%	20%	10%	50%	25%	70%	50%	20%	8%

\* These values may be reviewed by the JSE from time to time

\* Applied on orderbook re-entry of an instrument that had been temporarily halted on trading.

The number of possible extensions to an Auction Call session can occur as follows\*:

	Opening Auction Call	Continuous Trading Volatility Auction Call	Intra-Day Auction Call	Closing Auction Call	FCO Auction Call
Market Order Extension	1 (One)	1 (One)	1 (One)	1 (One)	1 (One)
Price Monitoring Extension	1 (One)	No Extension	No Extension	1 (One)	2 (Two)

This is an indication of the maximum number of extensions and may vary across trading Segments.

---

#### 8.6.5.1 **Evaluation during Continuous Trading**

The circuit breaker validation is carried out at the point of crossing each price point (i.e. – a potential trade which is going to cross the circuit breaker tolerance will be restricted).

When an order is aggressing the order book, the Static Reference Price and Dynamic Reference Price at the time the order started to aggress will be used for circuit breaker evaluation during the entire aggression as a Single Transaction.

When the circuit breaker is triggered for the instrument then the instrument will automatically be moved into a Volatility Auction Call session.

#### 8.6.5.2 **Price Monitoring Extension**

If the likely execution price at the end of the normal auction lies outside defined tolerances from the last traded price, then the auction call could be extended for a certain period to increase the likelihood that the price movement might be reduced. The duration of a Price Monitoring Extension is 5 minutes during all Auction Call sessions, except during the Futures Close Out Auction Call session where the extension period is 4 minutes long and during a Volatility Auction Call session last for 3 minutes.

#### 8.6.5.3 **Evaluation during an Auction and Price Monitoring Extensions**

If a circuit breaker tolerance is going to be breached by the Indicative Auction Price and if there are any price monitoring extensions defined for the instrument then the auction uncrossing will not be performed.

In such a scenario, the auction call session will be extended for the time period defined.

At the end of the extension period, the auction will be performed if there are no more price monitoring extensions available. If the Indicative Auction Price is still not within the tolerance, the auction call session will again be extended for the time period defined for the price monitoring extension. This process will be repeated until there are no further price monitoring extensions available at which point the auction uncrossing will be performed and the circuit breaker tolerance checks will not be performed based on a trade executed in the auction uncrossing due to there being no further price monitoring extensions available.

#### 8.6.5.4 **Market Order Extension**

If Market Orders within the order book are not executable or only partially executable (i.e. there is a Market Order imbalance) at the uncrossing of the auction call session, a Market Order extension will be triggered. The duration of a Market Order Extension is 2 minutes.

#### 8.6.5.5 **Market Order Extension/Price Monitoring Extension**

Market order extensions and price monitoring extensions can happen in any sequence. If there happens to be a market order extension and a price monitoring extension at the same time, market order extension always takes the priority over the price monitoring extension. Applicable market order extensions and price monitoring extensions for an instrument will be counted on an incremental basis for each type of extension, regardless of the sequence in which they happen.

#### 8.6.5.6 **Triggering the Volatility Auction Call Session**

During the Continuous Trading session, if the circuit breaker tolerance is going to be breached then the instrument will be automatically moved to the Volatility Auction Call session.

#### 8.6.5.7 **Handling the Remaining Quantity**

During the Continuous Trading session, the remainder of the aggressing order, which causes the circuit breaker tolerance breach, will either be added to the order book (if the time in force is a persistent one) or expired (if the time in force is not a persistent one).

---

Any IOC (including a Market Order with time in force IOC) will get expired in the event of a circuit breaker tolerance breach during the continuous trading session. The reason included in an Execution Report published to notify users that an order was expired due to a circuit breaker tolerance breach will be “Expired (circuit breaker breached)”.

#### 8.6.5.8 Real Time Alerts to Brokers

Clients who use the Drop Copy Gateway will have the option to receive a real time alert when one of their traders triggers a circuit breaker (including any missed circuit breaker alerts upon logging on).

### 8.6.6 Self-Match Prevention

Self-match prevention (SMP) is a functionality that allows market participants to prevent their own orders from matching against each other by using an optional unique key.

The following will apply for SMP:

- Only Member Firms that have opted for Self-Match Prevention can make use of the functionality. SMP will be enabled at a CompID level.
- The JSE will provide unique keys upon client request.
- Only these unique keys may be used for SMP.

The system is designed to prevent executions between orders marked with the same self-match key during continuous trading and closing price cross (CPX) sessions. Any incoming order that could result in an execution where the self-match keys are the same will trigger the resting order to be expired before trade can match.

Self-match prevention excludes pegged hidden orders, cross orders, and off-book trades and is not applicable during auction call sessions or for certain Time in Force (TIF) options like OPG, GFX, GFA or ATC. The permitted TIFs include DAY, IOC, FOK, GTC, GTT, GTD and CPX. The unique key will not be able to be amended, in order to maintain the integrity of the process. Stop orders and stop limit orders will only be eligible for execution once elected on the order book. Therefore, self-match prevention will be assessed once they become elected into the order book.

Within SMP, specific scenarios with order types like iceberg orders, and behaviours such as circuit breakers and Fill or Kill (FOK) TIF are crucial for effective trading.

#### 8.6.6.1 Self-Match Preventions and Circuit Breakers

The system will perform circuit breaker limit validation before conducting self-match prevention validation, as the current system setup has been configured to prevent trading when circuit breakers are triggered. This approach ensures that the system first verifies the limits of the circuit breakers before addressing any potential self-match. (Refer to appendix J for an example)

#### 8.6.6.2 Self-Match Preventions and Fill-Or-Kill Orders

When an FOK order is placed the system conducts an evaluation process that excludes self-matching quantities from the total consideration. The primary goal is to execute the FOK order immediately and in full. If there is not enough quantity available to fill the incoming FOK order without a potential self-match occurring, the FOK order will not be executed, and it will be expired. If there is sufficient non-self-matching quantity available to execute the FOK order, the executions proceed while handling any self-matching orders that may be encountered in sequence. Self-matching passive orders are expired during each execution, ensuring that the FOK order is filled with available non-self-matching quantities. This process continues until the FOK order is filled and there is no more passive quantity left to execute against.

The unique key can be used for iceberg orders. The sequence of execution depends on how passive iceberg orders are handled at the same price point in the order book. Upon entry of

---

an iceberg order with a unique key into the order book, the regular iceberg execution rules will apply. Should a potential self-match occur with an iceberg, the resting order will be expired.

Please refer to JSE Specification Document Volume 01E – Basic Native Trading Gateway and JSE Specification Document Volume 02 - Trading Gateway (FIX 5.0 SP2) for more information on the unique key. Illustrative examples of SMP functionality is available in appendix J for clarity and understanding.

## 8.7 Opening Price

The opening price of an Instrument will be determined by the first trade. This is the Opening Auction uncrossing trade price. If no opening auction takes place, the first automatic trade price will be the opening price.

If no trade happens for an Instrument there will be no opening price and accordingly, no opening price message will be published.

## 8.8 Closing Price

The process of determining the closing price for an Instrument is defined per Segment and is based on the following definitions:

### 8.8.1 Closing Price Definitions

The Closing Price calculation will be based on either of the following calculation methodologies:

- **Closing Auction:**

If an uncrossing did not take place in the Auction, then the secondary Closing Price Convention will apply.

- **Mid-point:**

The Instruments closing point will be the mid-point between the best bid and offer prices at the time the closing price is calculated.

Mid-Point –  $[\text{Best Bid Price} + \text{Best Offer Price}] / 2$

The calculated mid-point will always be the last mid-point of the Visible BBO during continuous trade.

If there is no Best Bid or Offer Price, the Closing Price will be the last on-book traded price for the day. If there are no trades for the entire day, the closing price will be the Best Bid Price or Best Offer Price, whichever is available. If there is no best Bid or Offer Price available, the closing price will be zero.

The mid-point will be calculated even if the Best Bid and Offer prices lock or cross.

- **VWAP:**

This will be the Closing Price based on the VWAP of On-book trades calculated within a defined time period (minutes) of trading prior to the point of calculating the Closing Price. This is currently 10 minutes.

VWAP is calculated as follows:

$$\text{VWAP} = \frac{\sum (\text{Trade Price}_i * \text{Trade Volume}_i)}{\sum \text{Trade Volume}}$$

Where;

Trade Price<sub>i</sub> – Price of the i<sup>th</sup> eligible trade (Only ATs and UTs are eligible trades)

Trade Volume<sub>i</sub> – Volume of the i<sup>th</sup> eligible trade (Only ATs and UTs are eligible trades)

If there were no trades during this period then the Closing Price will be the most recent On-book trade (automated or uncrossing). If there were no bids for the entire day, then the Closing Price will be the previous day's closing price.

If an Instrument has never been traded, then the Closing Price will be zero.

Closing Prices that are generated making use of the last traded price may at times be referencing an XT trade type with a decimal value e.g. 100.5. This value will always be rounded up to ensure the closing price does not carry any decimal values.

## 8.8.2 Closing Price Methodology

The following table defines both a Primary Closing Price and Secondary Closing Price methodology per Segment:

Segment	Primary Closing Price	Secondary Closing Price	Methodology
ZA01	Closing Auction	VWAP	Methodology 1
ZA02	Closing Auction	VWAP	Methodology 1
ZA03	Closing Auction	VWAP	Methodology 1
ZA04	Mid-point	None	Methodology 2
ZA06	Mid-point	Last AT/UT	Methodology 3
ZA11	Closing Auction	VWAP	Methodology 1
ZA12	Closing Auction	VWAP	Methodology 1

When combining these methods of calculation, the resultant methodology can be viewed as follows:

### 8.8.2.1 Methodology 1

The Closing Price will be the price of the uncrossing trades at the end of the closing auction.

- If there is no uncrossing, the VWAP (determined during the 10 minutes prior to the start of the closing auction) will be applied.
- If there is no VWAP, then the price of the last automated trade for the day will apply.
- If no automated trades or uncrossing took place then the Closing Price will be the Previous Close.
- For a new listing, if there has been no trade, the closing price will be zero.

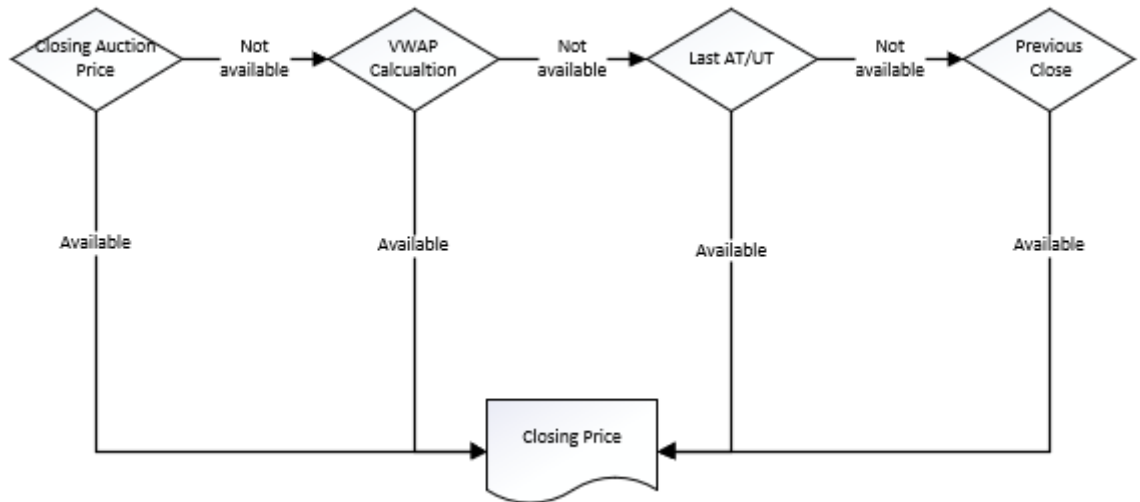

### 8.8.2.2 Methodology 2

The Closing Price will be based on the Mid-point of the last BBO during continuous trade (at the start of the Post Close Session).

- If only one side of the book contains orders at the end of continuous trading then the Closing Price will be the last Automated Trading or Uncrossing Trade for the day.
- If there have been no trades for the day and only one side of the book contains orders, the Closing Price will be the price of the best order of the particular side.
- If the book is empty, then the closing Price will reference the previous close.

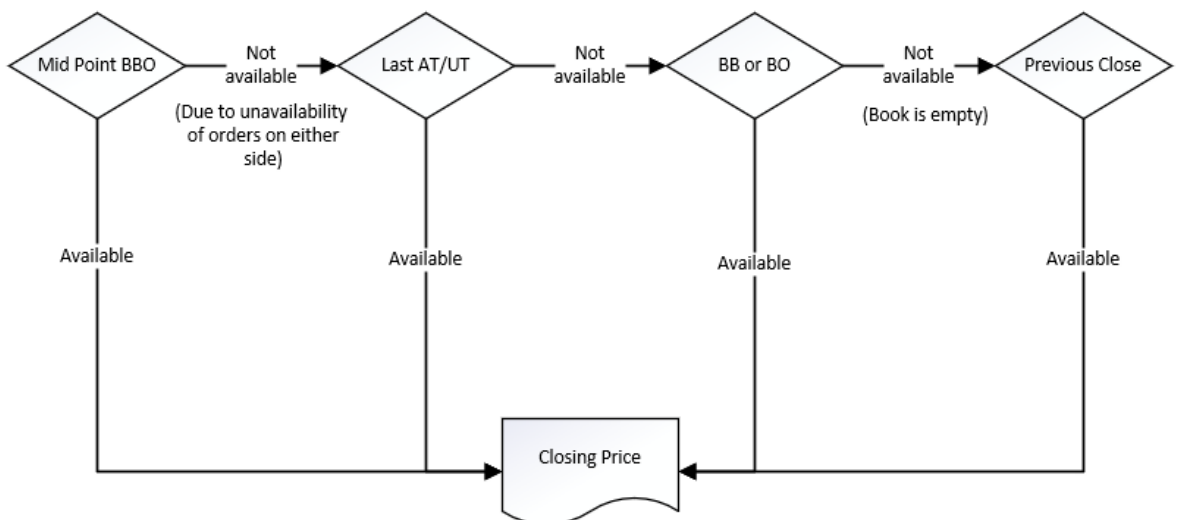

### 8.8.2.3 Methodology 3

There will no longer be an Opening and Closing Auction for trading segment ZA06

- and the mid-point of the last BBO during continuous trading will be the closing price determinant.



---

If there are insufficient orders to calculate the mid-point of the Visible BBO, then:

- The closing price will be the last Automated trade or Uncrossing Trade
- If there have been no Automated or Uncrossing trades for the day, then the closing price will reference the Previous Closing price of the instrument.

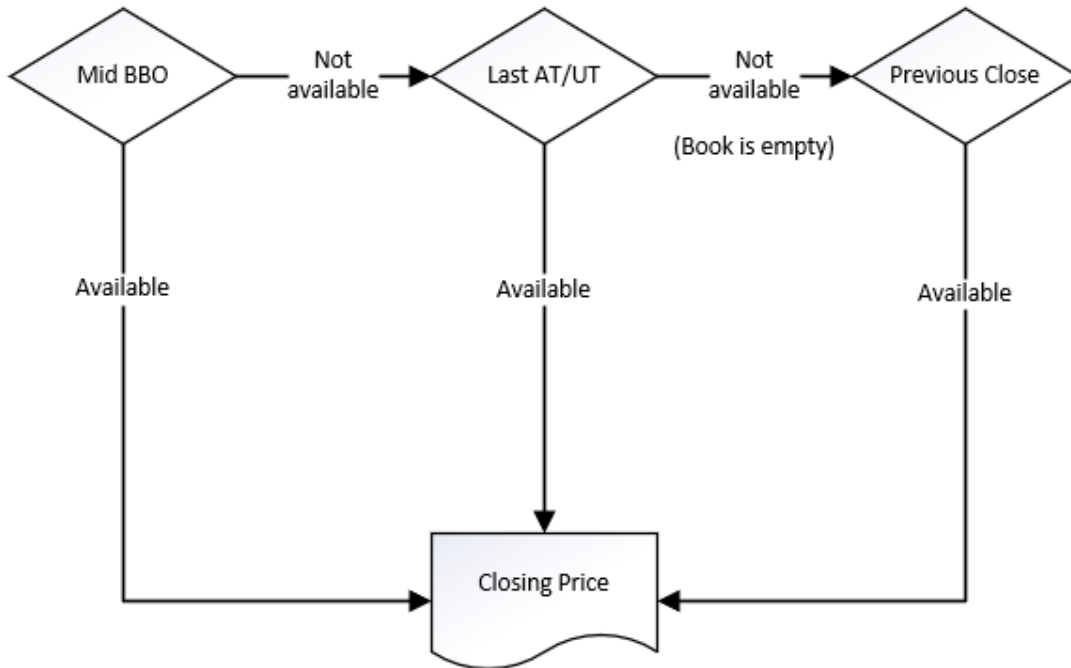

### 8.8.3 General Closing Price Information

- The closing price of an Instrument will be published to the relevant Market Data gateways.
- The method of determining the Closing Price (Methodology 1, 2 and 3) will be published together with the Closing Price.
- Closing prices will not contain any decimals. Should a closing price reference a trade with a decimal value, this will be rounded up to the next full cent amount.
- If an Instrument is suspended during a trading day (between Market Start and Market End), the closing price will be published automatically on suspension. If a closing price has already been published, another one will not be published.
- Similarly if the JSE performs a Halt and Close action for an instrument, then the closing price will automatically be published upon that action. The Previous Close is the Closing Price of an Instrument as published on the previous day.
- The Bid Price is the best bid price just before moving to the closing auction call.
- The Offer price is the best offer price just before moving to the closing auction call.
- The High Price is the Highest On-book trade price of the day that will be published. If there is no High Price for an Instrument then the first on-book trade to execute will be published as the High Price.
- The Low Price will be the lowest On-book trade price of the day. Where there is no Low Price, the first On-book trade to execute in the system will publish its low price for the day.
- When an instrument is suspended, the Closing Price will be published at the suspension. On the day(s) following suspension, if the instrument remains suspended, a Closing Price

---

will not be published at the end of the day. However, the Closing Price at the suspension will be carried forward as the Previous Close of the instrument.

---

## **9 REGULATORY NEWS SERVICE FOR JSE (SENS) AND NSX (NENS)**

The Stock Exchange News Service is used to enhance market transparency and investor confidence. Companies are obliged to disseminate any corporate news or price-sensitive information on the service prior to using any other media outlet. Please refer to Volume 08 - Regulatory News Feed (FAST-UDP) for more information.

---

## 10 TRADE REPORTING (OFF-BOOK TRADES)

The System supports the reporting and publication of trades concluded outside the central order book. Trades may be reported by one member using a single-sided trade report message or by both members using the dual-sided trade report functionality detailed in *sections 7.1 and 7.2*. Cancellation of Off Book trades are reported through the same mechanism.

Off Book trades needs to be reported to the System in accordance with the JSE Rules and Directives.

The reporting and cancellation Off Book trades must be submitted through the Post Trade Gateway and will be published via the Market Data Gateways based on their publication rules. The System will also publish Trade Capture Reports for confirmed Off Book trades via the Post Trade Gateway to the relevant Firm(s) who participated in the Off Book trade.

- All JSE & NSX Off Book Trades will be reported to the System using the Trade Capture Report (AE) message via the Post Trade Gateway.
- All Off Book Trades reported to the System will be reported with a valid Off Book Trade Type.
- Trade Types are valid for each market and therefore the segments that belong to each market.
  - (a) For the JSE Market it is segments: ZA01; ZA02; ZA03; ZA04; ZA06.
  - (b) For the NSX Market it is segments ZA11 and ZA12.
- A Trade Type will be associated with a Publication Indicator to indicate whether or not the Reported Trade will be published to the market.
- A Trade Type will be associated with an Update Statistics Indicator to indicate whether or not the Reported Trade will update the System statistics for the current trading day.
- A Trade Type will be associated with the Reporting Model which will indicate whether the Trade Type supports the Single Party Reporting Model, Dual Party Reporting Model or Both Reporting Models.
- A Trade Type will be associated with a valid combination of dealing capacities for both sides of the trade.
- On reporting a Trade the currency for the price will always be the instrument currency. For JSE markets this will be ZAC (South African Cents).
- The 'Publication Indicator' in the Trade Submission Request is not a mandatory field. If 'Publication Indicator' is not specified on the trade report, the trade report will still be accepted and the default Publication Type specified for the Trade Type table will be applicable. The default Publication Indicator for Off Book trades is Immediate Publication'. If the 'Publication Indicator' is specified on the trade report, the System will validate the specified value against the Publication Type specified in the Trade Type table and if this does not match it will reject the trade report.

### 10.1 Single Party Trade Reporting

Single Party Reporting Model can only be done by one Firm and the Firm would be required to enter all details of both sides of the trade (the Firm will be the same on both sides of the trade)

The initiating Firm will capture the following mandatory fields and submit a Trade Report Submission Request via a Trade Capture Report (TCR) (AE) message through a privileged Post Trade Interface User.

- Instrument ID
- Side of the Firm submitting the submission request (buy or sell)

- 
- Price of the trade
  - Size of the trade
  - Trade Type of the Off Book trade
  - Trade Reporting model of the Off Book trade
  - Trade Identifier assigned to trade by counterparties (there will only be one Trade Identifier for a single party reporting model as one firm submits both sides)
  - Date the trade was agreed between the Firms
  - Number of submitting party identifiers included on the message i.e. 3 (Firm, Trader Group, Trader)
  - Firm ID of the Firm submitting the submission request
  - Trader Group of the Trader submitting the submission request
  - Trader ID of the Trader submitting the submission request
  - Client Account of the Firm submitting the submission request
  - Dealing Capacity of the Trader submitting the submission request
  - Number of counterparty party identifiers included on the message i.e. 3 (counterparty Firm, Trader Group, Trader)
  - Counterparty Firm ID of the trade (same as initiating Firm)
  - Trader Group of the Trader in counterparty side
  - Trader ID of the Trader in counterparty side
  - Side of the counterparty Firm (buy or sell)
  - Client Account of the counterparty Firm
  - Dealing Capacity of the counterparty Firm
  - The trade report action for the Trade Capture Report i.e. submit/accept/decline/cancel/notification. In this instance it will be submit
  - The transaction identifier of the action i.e. new submission/ withdrawal/ response. In this instance it will be new submission
  - Number of sides reporting in the message

Upon receiving of the Trade Submission Request the System will perform the validations and will acknowledge the acceptance or rejection of the Trade Submission Request.

*Note:* A currency is required to be entered in the Settlement Currency field, if the Settlement Currency is different from the Instrument Currency. The recommended currency list will be iso-4217 currency list. The System does not validate the Settlement Currency upon submission of the trade report; the System will merely pass through what is in the field.

## Single Party Trade Reporting



Post Trade Interface User who submits the TCR (AE) to the System

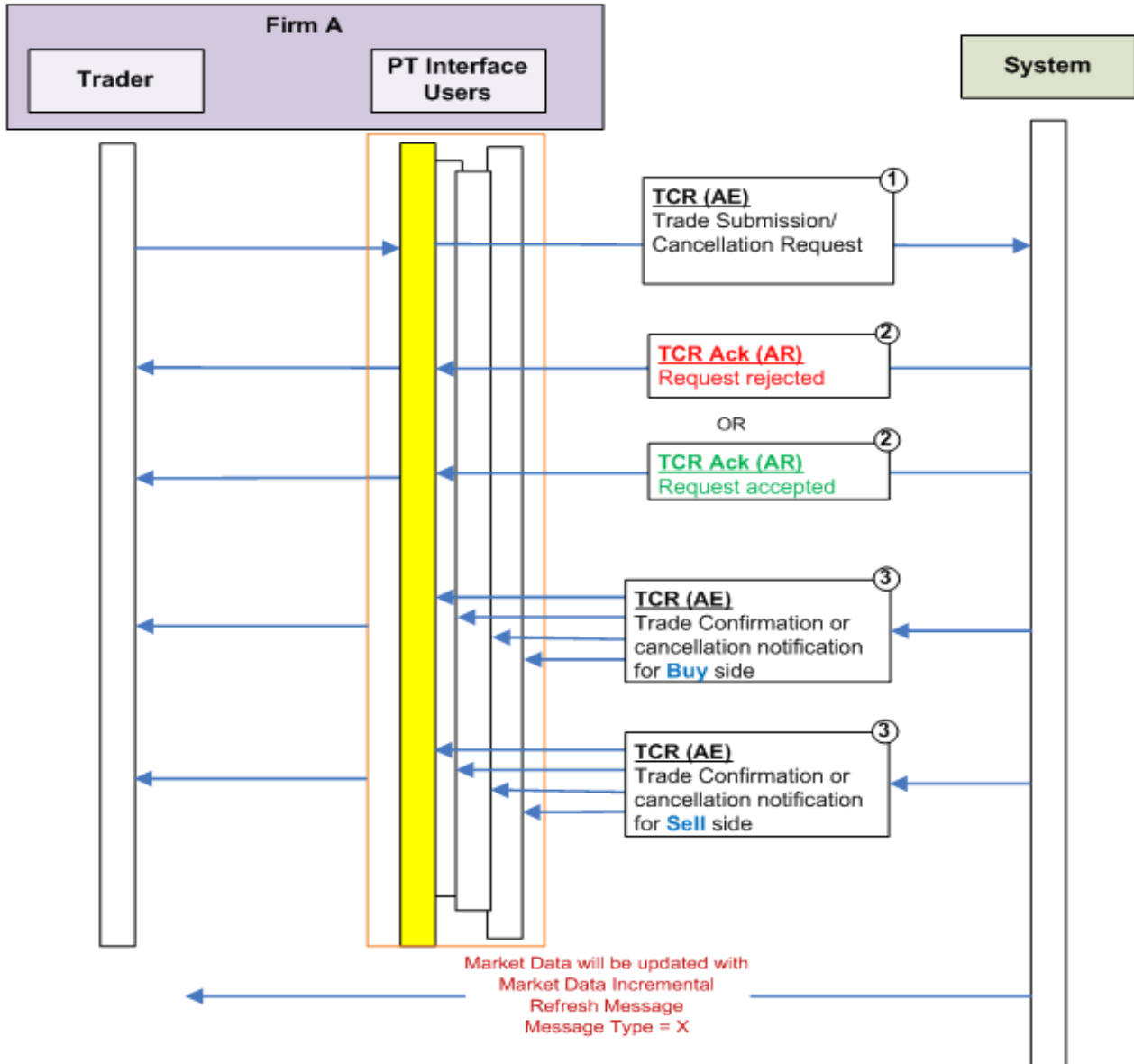

## 10.2 Dual Party Trade Reporting

The Dual Party Reporting Model must be used if the Buyer Firm is different to the Seller Firm for a trade and the reporting model of the Trade Type is either Both or Dual.

The initiating Firm is required to submit a Trade Report Submission Request with the details of the initiating Firm's side and only the counterparty Firm ID via TCR (AE) through a privileged Post Trade Interface User.

- Instrument ID
- Side of the Firm submitting the submission request (buy or sell)
- Price of the trade
- Size of the trade
- Trade Type of the Off Book trade

- 
- Trade Reporting model of the Off Book trade
  - Trade Identifier assigned to trade by counterparties
  - Date the trade was agreed between the Firms
  - Number of submitting party identifiers included on the message i.e. 3 (Firm, Trader Group, Trader)
  - Firm ID of the Firm submitting the submission request
  - Trader Group of the Trader submitting the submission request
  - Trader ID of the Trader submitting the submission request
  - Client Account of the Firm submitting the submission request
  - Dealing Capacity of the Trader submitting the submission request
  - Number of counterparty party identifiers included on the message i.e. 1 (counterparty Firm)
  - Counterparty Firm ID of the trade
  - The trade report action for the Trade Capture Report i.e. submit/accept/decline/cancel/notification. In this instance it will be submit
  - The transaction identifier of the action i.e. new submission/ withdrawal/ response. In this instance it will be new submission
  - Number of sides reporting in the message
  - Side of the counterparty Firm (buy or sell)

Upon receiving of the Trade Submission Request the System will perform the validations and will acknowledge the acceptance or rejection of the Trade Submission Request.

If the validations are passed and the trade is accepted by the System, the System will notify the counterparty Firm (i.e. the Firm on the other side of the trade).

The counterparty Firm will submit the Counterparty Response. The counterparty Firm will either;

- Decline the Trade Report via a TCR (AE).
- Complete all the necessary mandatory field details for the Firm's side of the trade and submit it to the System via a TCR (AE).

The following mandatory fields will need to be submitted by the counterparty:

- Instrument ID
- Unique trade identifier generated by the System for the trade;
- Number of sides reporting in the message. For the JSE Markets it will always be 2.
- Side of the counterparty Firm (i.e. buy or sell)
- Price of the trade
- Size of the trade
- Trade Type of the Off Book trade
- The transaction identifier of the action i.e. new submission/ withdrawal/ response. In this instance it will be response.
- The trade report action for the Trade Capture Report i.e. submit/ accept/ decline/ cancel/ notification. In this instance it will either be accept or decline
- Trade Reporting model of the Off Book trade

- 
- Trade Identifier assigned to trade by counterparties
  - Date the trade was agreed between the Firms
  - Firm ID of the Firm responding to the submission request
  - Trader Group of the Trader responding to the submission request
  - Trader ID of the Trader responding to the submission request
  - Client Account of the Firm responding to the submission request
  - Dealing Capacity of the Firm responding to the submission request
  - Number of responding party identifiers included on the message i.e. 3 (Firm, Trader Group, Trader)
  - Number of party identifiers for the party that submitted the original trade request i.e. 1 (Firm)
  - Firm ID of the party that originally submitted the trade request
  - Side of the submitting Firm (buy or sell)

The System validates the counterparty Firm response TCR (AE). If the Trade Submission Request is accepted by the counterparty Firm and the counterparty response passes the system validations, the system will transmit a confirmation TCR (AE) to both Firms.

If the Trade Submission Request is accepted by the counterparty Firm and the Counterparty Response TCR (AE) passes the validations performed by the System; the trade will be published on market data immediately it has been confirmed.

If the response from the counterparty fails validation, the initiating firm will not be notified of the rejection and the unconfirmed trade will expire at the end of the day.

The initiating Firm can withdraw the Trade Request as long as the request has not been accepted / declined by the counterparty.



## Dual Party Trade Reporting

 Post Trade Interface User who submits the TCR (AE) to the System (in initiating Firm and counterparty Firm)

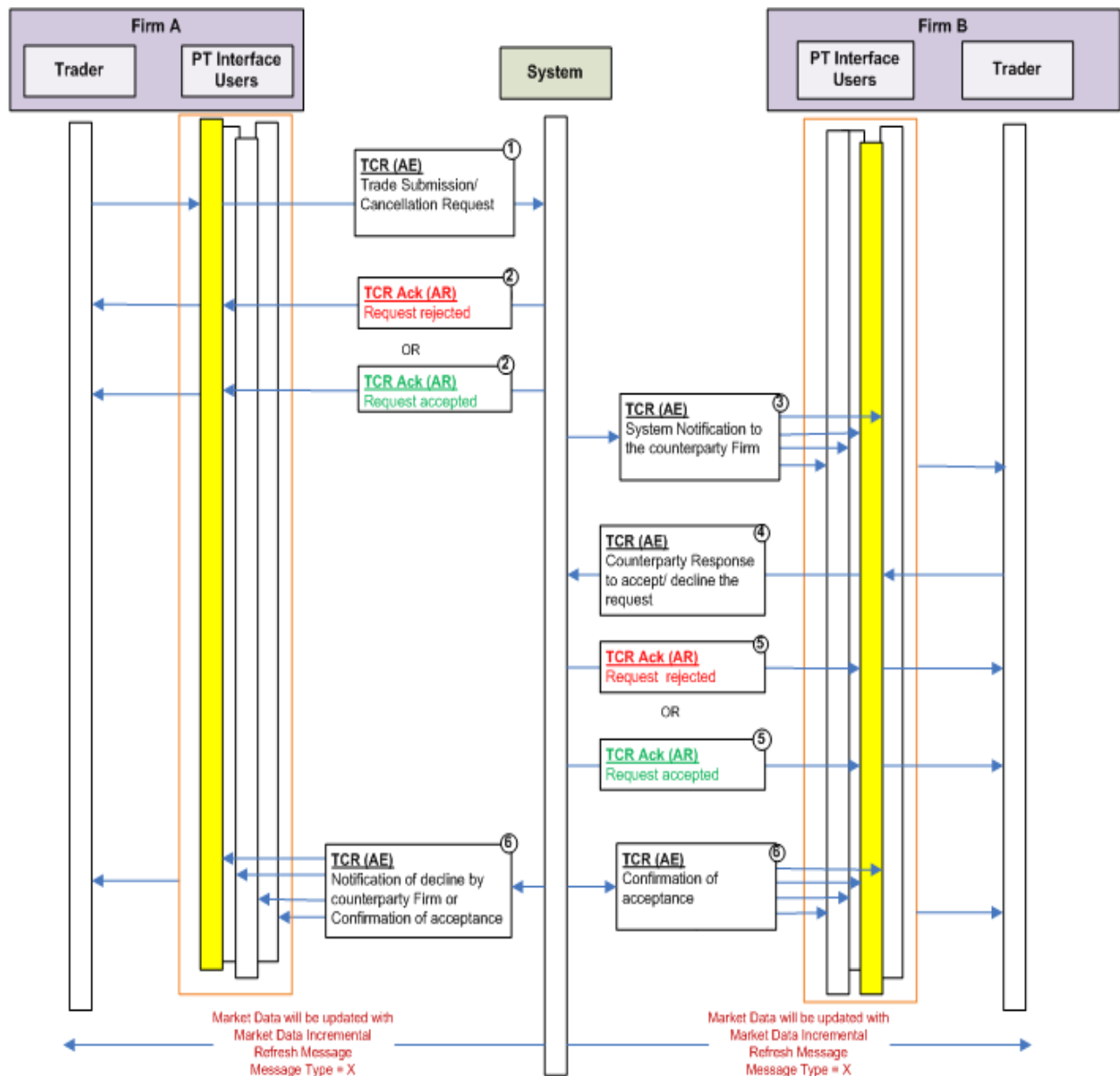

### 10.3 Validations

Trade reporting functionality will be enabled even if the instrument is suspended however, the following conditions will result in the trade being rejected:

- If the System comes up on a day that is not a valid JSE Trading Day (i.e., on a non-business day and a User tries to submit a trade report on the day).
- If it is not a valid Trade Type (Refer Appendix A – Trade types);
- If the capacity combinations are not valid for that Trade Type (Refer Appendix A – Trade types);
- If the Firm reports a Trade Type where the Reporting Model is not supported

- 
- If the Trader ID is invalid (does not exist in the System);
  - If the Trader/ Post Trade Interface User does not have the privileges to perform Off Book Trade Reporting;
  - If the Trader/ Trader Group/ Firm who submitted the TCR is suspended at the time of validation of the TCR that was submitted to the System
  - If the Initiating Trader/Trader Group/ Firm is suspended when the System validates any of the following;
    - a. Trade Submission Request
    - b. Trade Cancellation Request
    - c. Trade Submission Withdrawal Request
    - d. Trade Cancellation Withdrawal Request
  - If the counterparty Trader/Trader Group/ Firm is suspended when the System validates the following;
  - Counterparty Response for a Trade Submission Request or Trade Cancellation Request.
  - If a mandatory field is not populated;
  - If the Instrument does not exist in the System or its status in the System is inactive;
  - If it is not a valid Trade Reporting session;
  - If the date the trade was agreed between the Firms is greater than one trading day from the date the trade was reported to the System;
  - If the date the trade was agreed between the Firms is a future date;
  - If a PC, LC or NC has the date the original trade was reported by the parties as the current day;
  - If a PC, LC or NC does not have the original date the trade was reported to the system as the previous trading day;
  - If a PC, LC or NC does not have the field for the Trade ID of the original trade populated;
  - If a Publication Indicator is specified for the trade and it does not match against the Trade Type table.

NOTE: The JSE Markets allow for backdating of Off Book trades by one trading day only. These are not considered late trades as per current late trade System functionality

## **10.4 Trade Cancellations and Modification of Reported Trades**

Once a confirmed trade is reported to the system, participants involved in the trade can initiate a cancellation of the trade. Each cancellation request needs to uniquely identify the trade through the Trade ID.

### **10.4.1 Same day Off Book Trade Cancellations by Firms – Single Party**

Same day cancellations of Off Book Trades (single and dual party) must be submitted to the JSE equities trading system by the member who was the originator of the Off Book trade and do not require prior approval from the Director: Surveillance. The following procedure will apply:

---

The party who submitted the Off Book trade will initiate a Trade Cancellation Request via a TCR message through the Post Trade Gateway. The following fields are mandatory:

- Trade ID (Trade ID of the original trade)
- Instrument ID
- Side of the Firm requesting the cancellation (buy or sell)
- Trade Reporting model
- Number of sides reporting in the message
- Number of submitting party identifiers included on the message i.e. 3 (Firm, Trader Group, Trader)
- Firm ID of the Firm requesting the cancellation
- Trader Group of the Trader requesting the cancellation
- Trader ID of the Trader requesting the cancellation
- Dealing Capacity of the Trader requesting the cancellation
- Number of counterparty party identifiers included on the message i.e. 3 (counterparty Firm, Trader Group ID, Trader ID)
- Counterparty Firm ID of the trade
- Trader ID of the counterparty side
- Trader Group ID of the counterparty side
- Side of the counterparty Firm (buy or sell)
- Dealing Capacity of the counterparty Firm
- The transaction identifier of the action i.e. new submission/withdrawal/response. In this instance it will be new submission
- The trade report action for the trade capture report i.e. submit/accept/decline/cancel/notification. In this instance it will be submit.

On receipt of the Trade Capture cancellation request the System will check the following fields of the Cancellation Request against the trades available in the System to ensure it matches the original trade:

- Trade ID (Trade ID of the original trade)
- Instrument ID
- Side of the initiating Firm
- Side of the counterparty Firm
- Firm ID/ Trader Group ID/ Trader ID of the initiating Firm
- Dealing capacity of the initiating Firm
- Dealing capacity of the counterparty Firm
- Firm ID/ Trader ID and Trader Group ID of the counterparty Firm (in Single Party Reporting model - same as initiating Firm)

If the Trade Cancellation Request passes the above validations the System will acknowledge the receipt of the TCR using the TCR Ack message. If the submitted TCR is accepted, the System will generate a successful trade cancellation and notify the Firm through a TCR message.

The trade cancellation will be published on market data based on the Trade Type rules. System statistics will be updated accordingly.

---

The party that initiated the trade cancellation will not be able to withdraw the cancellation request and terminate the cancellation process.

If the Trade Cancellation Request fails the above validations, the System will reject the TCR using TCR Ack message.

#### **10.4.2 Same day Off Book Trade Cancellations by Firms – Dual Party**

- One of the parties to the trade may submit the Trade Cancellation Request via a Trade Capture Report message through the Post Trade Gateway. The following fields are mandatory: Trade ID (Trade ID of the original trade)
- Instrument ID
- Side of the Firm requesting the cancellation (buy or sell)
- Trade Reporting model
- Firm ID of the Firm requesting the cancellation
- Trader Group of the Trader requesting the cancellation
- Trader ID of the Trader requesting the cancellation
- Dealing Capacity of the Trader requesting the cancellation
- Counterparty Firm ID of the trade
- The trade report action for the trade capture report i.e. submit/accept/decline/cancel/notification. In this instance it will be cancel
- The transaction identifier of the action i.e. new submission/withdrawal/response. In this instance it will be new submission
- Number of sides reporting in the message
- Number of submitting party identifiers included on the message i.e. 3 (Firm, Trader Group, Trader)
- Number of counterparty party identifiers included on the message i.e. 1 (Firm)
- Side of the counterparty Firm (buy or sell)

The following additional validations will take place for the request:

- Trade ID (Trade ID of the original trade)
- Instrument ID
- Side of the Firm requesting the cancellation
- Firm ID/ Trader Group

If the Trade Cancellation Request passes the above validations the System will acknowledge the receipt of the TCR (AE) using TCR Ack (AR) message. If the Trade Cancellation Request fails the above validations the System will reject the TCR (AE) using TCR Ack (AR) message.

The Firm that initiated the trade cancellation will be able to withdraw the cancellation request via a TCR (AE) and terminate the cancellation process if the trade report has not been accepted/ declined by the counterparty Firm. The process of withdrawing a cancellation request is the same as the process of cancelling an Off Book trade in the Dual Party Trade Reporting model.

#### **10.4.3 Next day Off Book Trade Cancellations by Firms – Single Party**

Next day cancellations of Off Book Trades (single and dual party) must be submitted to the JSE equities trading system by the member who was the originator of the Off Book trade and do not require prior approval from the Director: Surveillance.

---

The party who submitted the trade will initiate a Trade Cancellation Request with an 'LC' or 'NC' trade type as an equal and opposite trade on the next trading day through a TCR message as they are both the buyer and seller to the trade. The System will not validate that an equal and opposite trade exists as the original trade was for the previous day and will not exist in the System.

This trade will have a new Trade ID generated for it and hence cannot be linked by the System to the original Off Book trade. The new trade is entered as a means of reversing the original trade.

Upon submission of a new Off Book trade in order to cancel an Off Book trade executed on the previous trading day, the following details of the original Off Book trade must be captured:

- Date the Original trade was reported to the System
- Trade ID of the Original trade to be cancelled

The following fields are also mandatory on submission of the next day Off Book trade cancellation request;

- Instrument ID
- Side of the Firm submitting the cancellation request (buy or sell)
- Price of the trade
- Size of the trade
- Date that the original trade was reported to the system
- Trade ID of the original trade to be cancelled
- Trade Type of the Off Book trade
- Trade Identifier assigned to trade by counterparties
- Date the trade was agreed between the Firms
- Trade Reporting model of the Off Book trade
- Firm ID of the Firm submitting the cancellation request
- Trader Group of the Trader submitting the cancellation request
- Trader ID of the Trader submitting the cancellation request
- Client Account of the Firm submitting the cancellation request
- Dealing Capacity of the Trader submitting the cancellation request
- Counterparty Firm ID of the trade
- Trader ID of the counterparty Firm
- Trader Group ID of the counterparty Firm
- Client Account of the counterparty Firm
- Dealing Capacity of the Trader of the counterparty Firm
- The trade report action for the trade capture report i.e. submit/accept/decline/cancel/notification. In this instance it will be cancel
- The transaction identifier of the action i.e. new submission/withdrawal/response. In this instance it will be new submission
- Number of sides reporting in the message
- Number of submitting party identifiers included on the message i.e. 3 (Firm, Trader Group, Trader)
- Number of counterparty party identifiers included on the message i.e. 1 (Firm)

- 
- Side of the counterparty Firm (buy or sell)

The System will validate the to ensure that Off Book trade is not backdated by more than one trading day. Based on the validations, the System will acknowledge the receipt of the TCR or will reject the same using TCR Ack message.

If the TCR is accepted by the System, and if the trade type is a 'LC' (Cancellation of a published Off Book trade ), then the trade will be published via Market data.

If the TCR is accepted by the System, and if the trade type is an 'NC' (Cancellation of a non-published Off Book trade ), then the trade will not be published via Market data

Both 'LC' and 'NC' trade types will not update the current day's System statistics to reflect the cancelled trade.

#### **10.4.4 Next day Off Book Trade Cancellations by Firms – Dual Party**

The behavior of Trade Cancellations of Off Book Trades in a Dual Reporting Model conducted on the next Trading Day will follow the procedure given below;

One of the parties to the trade will submit the Trade Cancellation Request as an 'LC' or 'NC' trade as an equal and opposite trade cancellation on the next trading day through a TCR message. The System will not validate that an equal and opposite trade exists as the original trade was for the previous day and will not exist in the System.

This trade will have a new Trade ID generated for it and hence cannot be linked by the System to the original Off Book trade. The new trade is entered as a means of reversing the original trade.

Upon submission of a new Off Book trade in order to cancel an Off Book trade executed on the previous day, the following details of the original Off Book trade must be captured:

- Date the original trade was reported to the System
- Trade ID of the original trade to be cancelled

The following fields are also be mandatory on submission of the next day Off Book trade cancellation request;

- Instrument ID
- Side of the Firm submitting the cancellation request (buy or sell)
- Price of the trade
- Size of the trade
- Date that the original trade was reported to the System
- Trade ID of the original trade to be cancelled
- Trade Type of the Off Book trade
- Trade Identifier assigned to trade by counterparties
- Date the trade was agreed between the Firms
- Trade Reporting model of the Off Book trade
- Firm ID of the Firm submitting the cancellation request
- Trader Group of the Trader submitting the cancellation request
- Trader ID of the Trader submitting the cancellation request
- Client Account of the Firm submitting the cancellation request
- Dealing Capacity of the Trader submitting the cancellation request
- Counterparty Firm ID of the trade

- 
- The trade report action for the trade capture report i.e. submit/accept/decline/cancel/notification. In this instance it will be submit
  - The transaction identifier of the action i.e. new submission/withdrawal/response. In this instance it will be new submission
  - Number of sides reporting in the message
  - Number of submitting party identifiers included on the message i.e. 3 (Firm, Trader Group, Trader)
  - Number of counterparty party identifiers included on the message i.e. 1 (Firm) Trader)
  - Side of the counterparty Firm (buy or sell)

The System will validate the TCR based on validations to ensure that Off Book trade is not backdated by more than one trading day. Based on the validations, the System will acknowledge the receipt of the TCR or will reject the same using TCR Ack message.

If the counterparty Firm accepts the trade report and the counterparty Firm response is accepted by the System, it will generate a successful trade cancellation and notify both Firms through TCR messages.

The Firm that submitted the request will not be notified if the response of the counterparty Firm fails validation and is rejected by the System and it will be expired at the end of the day.

- If the TCR (AE) is accepted by the System, and if the trade type is a 'LC' (Cancellation of a published Off Book trade ), then the trade will be published via Market data.
- If the TCR (AE) is accepted by the System, and if the trade type is an 'NC' (Cancellation of a non-published Off Book trade ), then the trade will not be published via Market data.

Both 'LC' and 'NC' trade types will not update the current day's System statistics to reflect the cancelled trade.

As the next day Off Book Trade Cancellation process is done through reporting a equal and opposite Trade Submission Request, the Firm that initiated the equal and opposite Trade Submission Request will be able to withdraw the request via a TCR (AE).

---

#### 10.4.5 Own Trades Book Download (OTBD)

All On Book and Off Book trades executed on the same day as the request (including cancellations) will be available on the own trade download functionality through the Post Trade Gateway.

Off Book trades which have been published prior to the date of the request will not be available through the own trade download functionality.

OTBD will always be requested for a particular Firm and Trader Group/Trader combination by the post trade gateway interface user.

If the request is successful, a copy of the trade capture report for all trades for the particular Firm, Trader Group/Trader combination will be sent by the System.

There is a limit to the number of own trades book download requests a post trade gateway user can use within a trading day; any request exceeding this amount will be rejected.

### 10.5 Trade Cancellation for On- Book Trades

#### 10.5.1 Next day Onbook Trade Cancellations by Firms – Single Party

A next day cancellation of an On Book trade is a transaction where a member cancels a trade executed in the central order book on the previous business day, subject to the provisions of the rules and directives of the JSE.

The party who submitted the trade will initiate a Trade Cancellation Request with 'PC' trade type as an equal and opposite transaction on the next trading day through a TCR message as they are both the buyer and the seller to the trade. The System will not validate that an equal and opposite trade exists as the original trade was for the previous day and will not exist in the System.

This trade will have a new Trade ID generated for it and hence cannot be linked by the System to the original On Book trade. The new trade is entered as a means of reversing the original trade.

The following details must be captured when submitting a TCR to cancel an onbook trade that was executed the previous day:

- Date the Original trade was executed on the system
- Trade ID of the Original trade to be cancelled
- Instrument ID
- Side of the Firm submitting the cancellation request (buy or sell)
- Price of the trade
- Size of the trade
- Trade type of the onbook trade



- Trade Identifier assigned to trade by counterparties
- Firm ID of the Firm submitting the cancellation request
- Trader Group of the Trader submitting the cancellation request
- Client Account of the counterparty Firm
- Dealing Capacity of the Trader of the counterparty Firm
- The trade report action for the trade capture report i.e. Submit/accept/decline/cancel/notification. In this instance it will be submit.
- The transaction identifier of the action i.e. new submission/withdrawal/response. In this instance it will be new submission
- Number of sides reporting in the message
- Number of submitting party identifiers included on the message. i.e 3 (Firm, Trader Group, Trader)
- Number of counterparty party identifiers included on the message i.e 1 (Firm)
- Side of the counterparty Firm (buy or sell)

The System will validate the TCR to ensure that On Book trade is not backdated by more than one trading day. Based on the validations, the System will acknowledge the receipt of the TCR or will reject the same using the TCR Ack message.

If the TCR is accepted by the System, and if the Trade type is a 'PC' (Cancellation of previous days on book trade), then the trade will be published via market data.

'PC' trade type will not update the current day's System statistics to reflect the cancelled trade.

### **10.5.2 Next day On Book Trade cancellation by Firms– Dual Party**

The behavior of Trade Cancellations for On Book Trades, where different members are on each side of the trade conducted on the next Trading Day, will follow the procedure outlined below:

One of the parties to the trade will submit the Trade Cancellation Request as 'PC' trade as an equal and opposite trade cancellation on the next trading day through a TCR message. The System will not validate that an equal and opposite trade exists as the original trade was for the previous day and will not exist in the System.

This trade will have a new Trade ID generated for it and hence cannot be linked by the System to the original Off Book trade. The new trade is entered as a means of reversing the original trade.

The following details must be captured when submitting a TCR to cancel an onbook trade that executed the previous day:

- Date the original trade was executed on the system
- Trade ID of the original trade to be cancelled
- Instrument ID
- Side of the Firm submitting the cancellation request(buy or sell)
- Price of the trade
- Size of the trade
- Trade type of the On Book trade
- Trade identifier assigned to trade by counterparties
- Firm ID of the Firm submitting the cancellation request

- 
- Client Account of the Firm submitting the cancellation request
  - Trader Group of the Trader submitting the cancellation request
  - Trader ID of the Trader submitting the cancellation request
  - Dealing Capacity of the Trader submitting the cancellation request
  - Counterparty Firm ID of the trade
  - The trade report action for the trade capture report i.e. submit/accept/decline/cancel/notification. In this instance it will be submit
  - The transaction identifier of the action i.e. new submission/withdrawal/response. In this instance it will be new submission
  - Number of sides reporting in the message
  - Number of submitting party identifiers included on the message i.e. 3 (Firm, Trader Group, Trader)
  - Number of counterparty party identifiers included on the message i.e. 1 (Firm) Trader)
  - Side of the counterparty Firm (buy or sell)

The System will validate the TCR based on validations to ensure that On Book trade is not backdated by more than one trading day. Based on the validations, the System will acknowledge the receipt of the TCR or will reject the same using TCR Ack message.

If the counterparty Firm accepts the trade report and the counterparty Firm response is accepted by the System, it will generate a successful trade cancellation and notify both Firms through TCR messages.

The Firm that submitted the request will not be notified if the response of the counterparty Firm fails validation and is rejected by the System and it will be expired at the end of the day.

If the TCR is accepted by the System, and if the Trade type is a 'PC' (Cancellation of previous day's on book trade), then the trade will be published via market data.

'PC' trade type will not update the current day's System statistics to reflect the cancelled trade.

As the next day On Book Trade Cancellation process is done through reporting an equal and opposite Trade Submission Request, the Firm that initiated the equal and opposite Trade Submission Request will be able to withdraw the request via a TCR (AE).

## Trade Cancellations

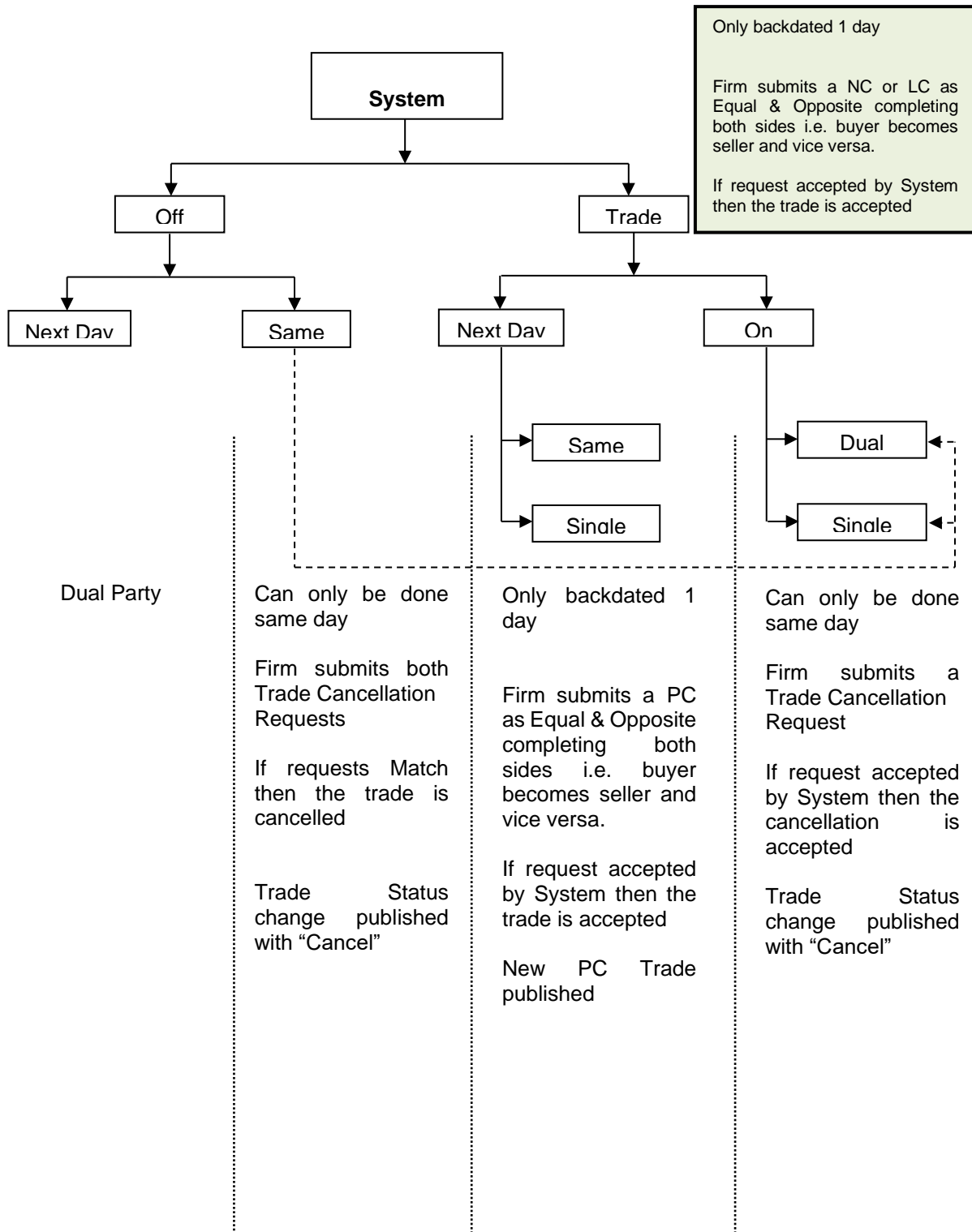

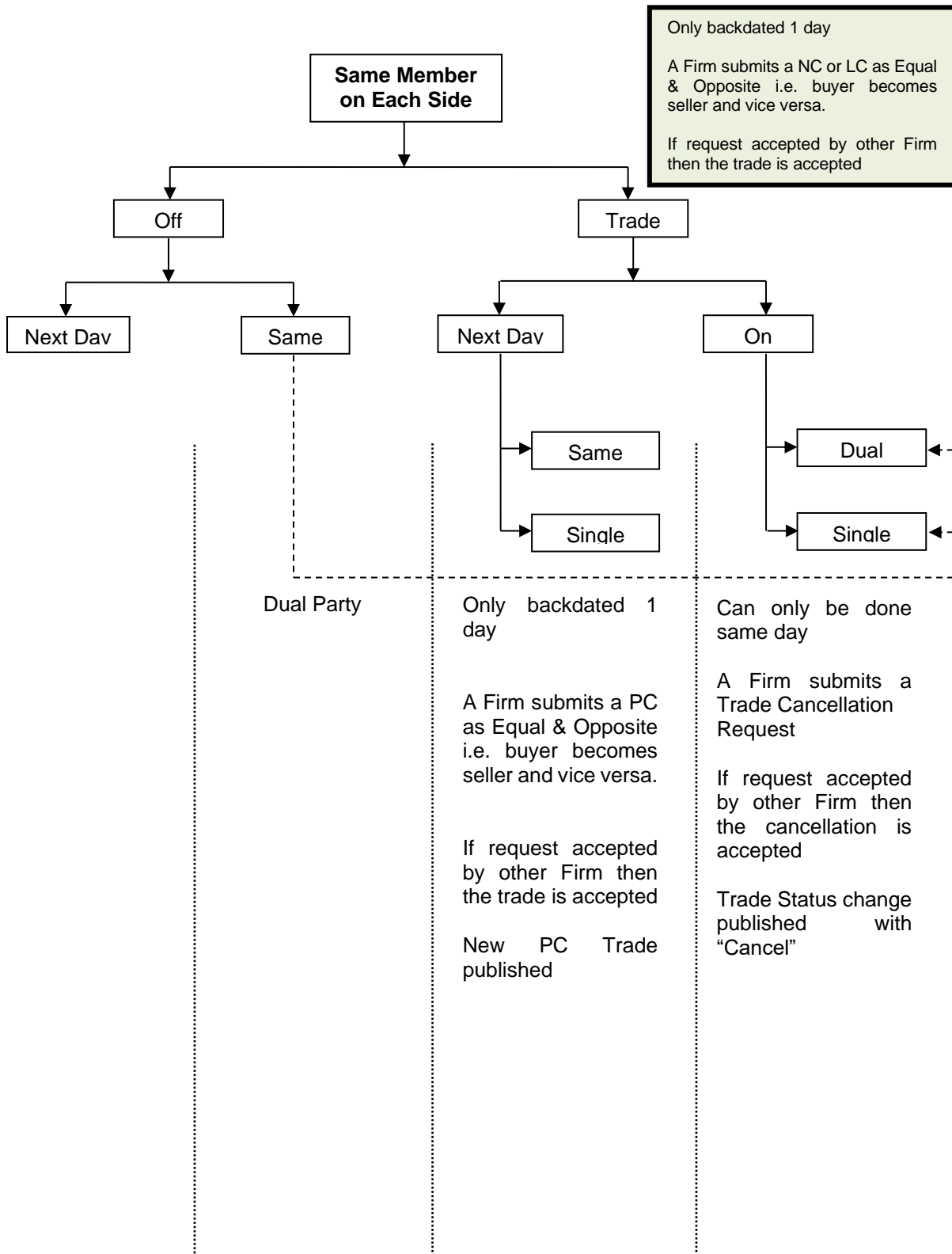

## 11 APPENDIX A – Trade Types

TrdSubType (829) Value	Trade Name	Trade Type	Dealing Capacity	Reporting Model	Market	Published to Market Y/N	Include In Cumulative Statistics for Current Trading Day
1014	Automated Trade	AT	A-A, A-P, P-A, P-P	N/A	JSE (ZA01, ZA02, ZA03, ZA04, ZA06) NSX (ZA11, ZA12)	Y	Y
1015	Uncrossing Trade	UT	A-A, A-P, P-A, P-P	N/A	JSE (ZA01, ZA02, ZA03, ZA04, ZA06) NSX (ZA11, ZA12)	Y	Y
1016	Cross Trades	XT	A-A, A-P, P-A, P-P	N/A	JSE (ZA01, ZA02, ZA03, ZA04, ZA06) NSX (ZA11, ZA12)	Y	N
1017	EOD Volume Auction Trade	VT	A-A, A-P, P-A, P-P	N/A	JSE (ZA01, ZA02, ZA03)	Y	Y
2001	Block Trade	BT	A-A, A-P, P-A, P-P	Both	JSE (ZA01, ZA02, ZA03, ZA04, ZA06) NSX (ZA11, ZA12)	Y*	Y
3001	Book Build	BK	A-A, P-P, P-A, A-P	Dual	JSE (ZA01, ZA02, ZA03, ZA04, ZA06) NSX (ZA11, ZA12)	Y	Y
2002	Corporate Finance Trade	CF	A-A, A-P, P-A, P-P	Both	JSE (ZA01, ZA02, ZA03, ZA04, ZA06) NSX (ZA11, ZA12)	Y	Y
2005	Delta Trade	OD	P-P, P-A, A-A, A-P	Dual	JSE (ZA01, ZA02, ZA03, ZA04, ZA06) NSX (ZA11, ZA12)	N	N
2013	Give Up	GU	P-P, A-P, P-A	Dual	JSE (ZA01, ZA02, ZA03, ZA04, ZA06) NSX (ZA11, ZA12)	N	N
17	Post Contra Trade (correction of previous day's published off book trade )	LC	A-A, A-P, P-A, P-P	Both	JSE (ZA01, ZA02, ZA03, ZA04, ZA06) NSX (ZA11, ZA12)	Y	N
3015	Post Contra Trade (correction of previous day's non-published off book trade )	NC	A-A, A-P, P-A, P-P	Both	JSE (ZA01, ZA02, ZA03, ZA04, ZA06) NSX (ZA11, ZA12)	N	N
2003	Late Trade (After Hours Trade)	LT	A-A, P-A, A-P, P-P	Single	JSE (ZA01, ZA02, ZA03, ZA04, ZA06) NSX (ZA11, ZA12)	Y	Y
2004	Namibia Trade	NX	A-A	Single	NSX (ZA11, ZA12)	Y	Y
2006	Off Order Book Principal Trade	OP	P-P	Single	JSE (ZA01, ZA02, ZA03, ZA04, ZA06) NSX (ZA11, ZA12)	Y	Y
2007	Option Exercised	OX	A-A, P-P, A-P, P-A	Both	JSE (ZA01, ZA02, ZA03, ZA04, ZA06)	N	N

TrdSubType (829) Value	Trade Name	Trade Type	Dealing Capacity	Reporting Model	Market	Published to Market Y/N	Include In Cumulative Statistics for Current Trading Day
					NSX (ZA11, ZA12)		
2009	Portfolio Trade	PF	A-A, P-A, A-P, P-P	Both	JSE (ZA01, ZA02, ZA03, ZA04, ZA06) NSX (ZA11, ZA12)	Y	Y
24	Post Contra Trade (correction of previous day's on book trade)	PC	A-A, A-P, P-A, P-P	Both	JSE (ZA01, ZA02, ZA03, ZA04, ZA06) NSX (ZA11, ZA12)	Y	N
2008	Traded Option Exercised	TX	A-A, P-P, A-P, P-A	Both	JSE (ZA01, ZA02, ZA03, ZA04, ZA06) NSX (ZA11, ZA12)	N	N
2011	Warrant Exercised	WX	A-A, P-P, A-P, P-A	Both	JSE (ZA01, ZA02, ZA03, ZA04, ZA06) NSX (ZA11, ZA12)	N	N
2010	Matched Principal	MP	P-P	Single	JSE (ZA01, ZA02, ZA03, ZA04, ZA06)	N	N
3016	Book Over Trade	BO	A-A, P-P, A-P, P-A	Both	JSE (ZA01, ZA02, ZA03, ZA04, ZA06) NSX (ZA11, ZA12)	Y	Y

\* A delayed market publication model will apply to all traded volumes for a specified period configured by the JSE. Any trades that may result in the trade being published after the market end time will be published at the start of post close for the Off-Book,

---

## 12 APPENDIX B – Valid Corporate Action Indicators (Ex Markers and Annotations)

The following Ex-marker codes are available on the JSE and NSX markets. These are allocated to instruments to indicate the status of the instrument or associated company.

### Ex-Markers:-

'GT'	Green Triangle – Declared Payment (dividend or other type of payment) still to be paid
'XD'	Ex-Dividend or other payment

### Annotations:-

'A'	Adverse Auditors Opinion Expressed
'D'	Disclaimed Annual Audit Opinion
'E'	Annual Audit Report “Emphasis of matter” paragraph
'G'	Going Concern
'OT'	Orange Triangle – Caution in dealing in shares
'Q'	Qualified Annual Audit Opinion
'R'	Failure to Provide Annual Compliance Certificate
'RE'	Red Square – Company Violation of the JSE Rules
'SV'	Shareholder Spread Violation
'TA'	Tax Applicable

## 13 APPENDIX C – Trading Liquidity Parameters

To assist with the assignment of instruments to various segments, additional liquidity characteristics of instruments are used as guidelines. Instruments are given a liquidity rating of 1-3 depending on how they fulfil certain trading criteria. A rating of 1 or 2 implies a liquid instrument while a rating of 3 implies a less liquid instrument, with 1 being the most liquid and 3 being the least liquid. This is summarised in the table below:

JSE Liquidity Rating	Ave Value Traded pm*	Parameter	% Days Traded	Parameter	Instrument sub-type
1	>R100,000,000	AND	>=75%	OR	Debenture (DB), Kruger Rand (KR), Preference Share (PS), Exchange Traded Funds (TF)
2	>R30,000,000	AND	>=33%		
3	<R30,000,000	OR	<33%	OR	Warrant (WR), Investment Product (IP), Nil Paid Letter (NL) and Exchange Traded Notes

\* - Calculated over a 3 month period.



## 14 APPENDIX D – PEGGED HIDDEN ORDER FUNCTIONALITY WORKED EXAMPLES

All previous Hidden Order examples have been removed from the document and completely replaced by the following examples:

### 14.1.1 Example: Incoming Buy Visible order

Pegged orders will be displayed in brackets

- PM = Pegged to Mid-Point
- PO = Pegged to Offer
- PB = Pegged to Bid
- Price Improvement = 0.5

Main Order Book						Pegged Order container ( Price- Time)					
Mid-point = 105											
Order ID	Bid Size	Bid Price	Offer Price	Offer Size	Order ID	Order ID	Bid Size	Hard limit	Hard limit	Offer Size	Order ID
O1	10000	100	110	1000	O2					[1000](MES1000)PM	P1
										[900](MES 900)PO	P2
Incoming Visible Buy order O3 2900 @ 110 O3 executes qty of 1000 with P1 @ 105 O3 executes qty of 900 with P2 @ 109.5 O3 executes qty of 1000 with O2 @ 110 Order books is as follows:											
Mid-point = No Mid-Point											
Order ID	Bid Size	Bid Price	Offer Price	Offer Size	Order ID	Order id	Bid Size	Hard limit	Hard limit	Offer Size	Order ID
O1	10000	100									

### 14.1.2 Example: Incoming Sell Visible order

Main Order Book						Pegged Order container ( Price- Time)					
Mid-point = 105											
Order ID	Bid Size	Bid Price	Offer Price	Offer Size	Order ID	Order ID	Bid Size	Hard limit	Hard limit	Offer Size	Order ID
O1	1000	100	110	1000	O2	P1	[800](MES800)PM				
						P2	[900](MES 900)PB				
Incoming Visible Sell order O3 2900 @ 99 O3 executes qty of 800 with P1 @ 105 O3 executes qty of 900 with P2 @ 100.5 O3 executes qty of 1000 with O1 @ 100 Rest of the O3 qty is added to the book Order books is as follows:											
Order ID	Bid Size	Bid Price	Offer Price	Offer Size	Order ID	Order id	Bid Size	Hard limit	Hard limit	Offer Size	Order ID
			99	200	O3						

			110	1000	O2										
--	--	--	-----	------	----	--	--	--	--	--	--	--	--	--	--

## 14.2 Appendix E – Examples Of When Pegged Hidden Orders Will Be Deleted/Expired

**a) If the quantity remaining on the order is < Minimum Reserve Size → Order will be expired.**

Order Volume = 1 250 000  
 MRS = 1 000 000  
 MES = 1 000 000

Order is matched, trades 1 000 000

Remainder is:

Order Volume = 250 000  
 MRS = 1 000 000  
 MES = 1 000 000

Order will therefore be expired.

**b) If the quantity remaining on the order is  $\geq$  Minimum Reserve Size but < MES → Order will be expired.**

Order Volume = 9500  
 MRS = 4000  
 MES = 5000  
 Order is matched, trades 5000

Remainder is:

Order Volume 4500  
 MRS = 4000  
 MES = 5000

Order will therefore be expired.

**c) If the quantity remaining on the order is  $\geq$  Minimum Reserve Size and  $\geq$  MES → Order will remain in the book or expired (pertaining to the time in force of the order).**

Order Volume = 2 000 000  
 MRS = 1 000 000  
 MES = 1 000 000

Order is matched, trades 1 000 000

Remainder is :

Order Volume = 1 000 000  
 MRS = 1 000 000  
 MES = 1 000 000

---

Order will remain on the book.

## 15 APPENDIX F – Examples Of Stop And Stop Limit Orders

### STOP ORDER

Step 01:

Order book contains three Passive orders on the Sell side. There is also an unelected Buy Stop order (Order 10) with a Stop price of 90 in the Order book

BUY			SELL		
Order ID	Size	Price	Order ID	Size	Price
			12	90	1000
			13	92	2000
10	1000		14	94	1000

Step 02:

Incoming Buy order 2000 @93 aggresses the Order book

BUY			SELL		
Order ID	Quantity	Price	Order ID	Quantity	Price
11	2000	93	12	90	1000
			13	92	2000
10	1000		14	94	1000

Step 03:

The incoming aggressing order 2000 @93 will be sweeping multiple price points (90 and 92) in the Order book and once it completes its execution, the Buy Stop order with a Stop price of 90 will get elected to the Order book. The following executions will occur:

1000@90 (Order 11 and 12)

1000@92 (Order 11 and 13)

Step 04:

Post completion of execution of the Aggressing order the elected Buy Stop order will get executed against the remaining quantity of the partially filled order on the contra side resulting in the following trade:

1000@92 (Order 10 and 13)

## STOP LIMIT ORDER

Step 01:

There is one LO on either side of the book and one Stop Limit order in an unelected state. The stop price for the order is 105 and the limit price is 106.

BUY					SELL				
Order ID	Type	Stop Price	Size	Price	Price	Size	Stop Price	Type	Order ID
1	LO		1000	104	107	1000		LO	2
					106	12000	105	SL	

Step 02:

Orders 3,4 and 5 enter the order book and the stop order is then elected. Trades occur between order 3 and 5:

15000 @ 105

BUY					SELL				
Order ID	Type	Stop Price	Size	Price	Price	Size	Stop Price	Type	Order ID
4	MO		12000	106	106	12000	105	SL	6
3	LO		15000	105	105	15000	105	SL	5
1	LO		1000	104	107	1000			2

Step 03:

The Stop Limit Order is then elected and executes with order 4:

12000 @ 106

## 16 APPENDIX G – Summary of Fix Vs Native Values For Key Fields on Orders and Trades

ENTITY	DESCRIPTION	BUSINESS TERM	NATIVE	FIX	COMMENT
Order Type	Market Order	MO	1	1	
	Limit Order	LO	2	2	
	Stop Order	SO	3	3	
	Stop Limit Order	SL	4	4	
	Cross Order	XT	5	5	
	Pegged Order	PO	50	P	
	Pegged Limit Order	PL	51	R	
TIF	Day	DAY	0	0	
	Immediate to Cancel	IOC	3	3	
	Fill or Kill	FOK	4	4	
	At the Open	OPG	5	2	
	At the Close	ATC	10	7	
	Good for Auction	GFA	9	9	
	Good for Intra-Day Auction	GFX	51	8	
	Good Till Time	GTT	8	6	Must have Expire time
	Good Till Date	GTD	6	6	Must have Expire date
	Good Till Cancel	GTC	1	1	
	Closing Price Cross	CPX	12	a	
	Good for Volume Auction	GDX	50	0	
	Exec Type	New		0	0
Rejected			8	8	
Trade			F	F	
Expired			C	C	
Cancelled			4	4	
Amended/Modified			5	5	
Triggered			L	L	
Suspended			9	9	
Restated (Order Cancel/Replace by Market Operations)			D	D	
Trade Cancel			H	H	
Trade Correct			G	G	

ENTITY	DESCRIPTION	BUSINESS TERM	NATIVE	FIX	COMMENT
<b>Order Status</b>	New		0	0	
	Rejected		8	8	
	Trade		1,2	1,2	
	Expired		6	C	
	Cancelled		4	4	
	Amended/Modified		0,1	0,1	
	Triggered		0,1	0,1	
	Suspended		9	0,1	
	Restated (Order Cancel/Replace by Market Operations)		0,1	0,1	
	Trade Cancel		0,1,4,6	0,1,4,C	
	Trade Correct		1,2,4,6	1,2,4,C	
<b>Side</b>	Buy	B	1	1	
	Sell	S	2	2	
<b>Capacity</b>	Principal	P	2	P	
	Agency	A	3	A	
<b>Trade Type</b>	Automated	AT		1014	
	Uncrossing	UT		1015	
	Book Build	BK		3001	
	Block Trade	BT		2001	
	Corporate Finance Trade	CF		2002	
	Give Up	GU		2013	
	Cancellation of Previous Day's published Off Book Trade	LC		24	
	Cancellation of Previous Day's non-published Off Book Trade	LC		17	
	Late Trade	LT		2003	
	Cancellation of Previous Day's non-published Off Book Trade	NC		3015	
	Namibia Trade	NX		2004	
	Delta Trade	OD		2005	
	Off Order Book Principal Trade	OP		2006	
	Option	OX		2007	
	Portfolio Trade	PF		2009	
	Traded Option Exercised	TX		2008	
	Warrant	WX		2011	
	Cross Trade	XT		1016	
	EOD Volume Auction Call Trade	VT		1017	

## 17 APPENDIX H – EOD VOLUME AUCTION Worked

Closing Price = 105

Central Order Book:

ID	Opt in to VA	Bid Size	Bid Price	Offer Price	Offer Size	Opt in to VA	ID
O1	Yes	100	107				
O2	No	300	106				
O3	Yes	500	106				

Pegged Order Book:

ID	Opt in to VA	Bid Size	MES	Hard Limit	Hard Limit	Offer Size	MES	Opt in to VA	ID
P1	Yes	600	300	104	103	300	300	Yes	P3
P2	Yes	300	300		104	700	700	No	P4
						400	400	Yes	P5
					105	200	200	Yes	P6

GDX Container:

ID	Bid Size	Limit Price	Limit Price	Offer Size	ID
G1	600	105	105	500	G4
G2	300	105	107	800	G5
G3	200	107			

The CPX session will be the trigger for the Volume Auction Uncrossing.

Step 01: At the start of CPX Session all eligible pegged orders will be injected into the bottom of the GDX Container

Step 02: The GDX container at the start of the EOD Volume Auction Call Session:

ID	Bid Size	Limit Price	Limit Price	Offer Size	ID
G1	600	105	105	500	G4
G2	300	105	103	300	P3
G3	200	107	105	200	P6

Step 03: The GDX will first aggress the central order book resulting in the following trades:



---

Buy ID	Sell ID	Price	Size	Trade ID
O1	G4	105	100	T1
O3	G4	105	400	T2
O3	P3	105	100	T3

Step 04: The sell side of the GDx container will then aggress the buy side of the GDx container resulting in the following trades:

Buy ID	Sell ID	Price	Size	Trade ID
G1	P3	105	200	T4
G1	P6	105	200	T5

Step 05: A single Auction Trade message will be generated and disseminated via the MDGs at the end of the uncrossing:

Trade Sub-Type	Price	Size
VT	105	1000

## 18 APPENDIX I – ICEBERG ORDERS WORKED EXAMPLES

### 18.1.1 Example: Passive Iceberg Order Execution and Replenishment

\* Note: the value in brackets represents the hidden quantity of the Iceberg Order. This is used for the purpose of the examples and will not actually show on the public order book.

Main Order Book					
Order ID	Bid Size	Bid Price	Offer Price	Offer Size	Order ID
B1	100 (4000)*	10			
<p>Visible Sell order S1 1000 @ 10 aggresses the main order book. The system will execute the entire aggressive (sell) order prior to replenishment, first executing against the visible quantity of the Iceberg Order and then the hidden quantity.</p> <p>Trade 1: B1 executes visible qty of 100 with S1 @ 10. The display qty for B1 will be 0 and the remaining qty 4000. Trade 2: B1 executes hidden qty of 900 with S1 @ 10. The display qty for B1 will be 0 and the remaining qty 3100.</p> <p>B1 will replenish based on the Random Replenishment % (e.g. 30%), with the resulting order book having a visible qty between the Upper and Lower Replenishment Limits: Upper Limit = Initial Visible Quantity = 100 Lower Limit = Initial Visible Quantity x [1 - 30%] = 100 x [1 - 0,3] = 70</p>					
Order ID	Bid Size	Bid Price	Offer Price	Offer Size	Order ID
B1R	80 (3020)*	10			

### 18.1.2 Example: Aggressive Iceberg Order Execution

Main Order Book					
Order ID	Bid Size	Bid Price	Offer Price	Offer Size	Order ID
			10	1200	S1
			10	850	S2
<p>Iceberg Buy order B1 with 10000 total quantity @ 10 aggresses the main order book. Trader B1 has specified a disclosed (peak) size of 1000. The aggressing Iceberg Order seeks to execute its full quantity. The Iceberg Order aggresses the order book and immediately matches with S1 and S2 @ 10.</p> <p>Trade 1: S1 executes qty 1200 with B1 @ 10. Trade 2: S2 executes qty 850 with B1 @ 10.</p> <p>At the end of the aggression, B1 has 7950 remaining quantity. As Trader B1 had initially specified a peak size of 1000, the system will add B1 to the order book, with 1000 visible quantity. Note: The visible quantity posted in the order book at the end of the aggression will be the lower of the disclosed quantity and the remaining quantity. The order book will look as follows:</p>					
Order ID	Bid Size	Bid Price	Offer Price	Offer Size	Order ID
B1	1000 (6950)*	10			

### 18.1.3 Example: Pro-Rated Iceberg Hidden Quantity Policy

Main Order Book					
Order ID	Bid Size	Bid Price	Offer Price	Offer Size	Order ID
B1	100 (400)	10			
B2	200 (600)	10			

Visible Sell order S1 800 @ 10 aggresses the order book.  
The system will execute the entire aggressive (sell) order prior to replenishment, first executing against the visible quantity of the Iceberg Order and then the hidden quantity.

**Visible Executions:** At the same price of 10, B1 has time priority over B2 and thus will trade first.  
Trade 1: B1 executes visible qty of 100 with S1 @ 10. The display qty for B1 will be 0 and the remaining qty 400.  
Trade 2: B2 executes visible qty of 200 with S1 @ 10. The display qty for B2 will be 0 and the remaining qty 600.

**Hidden Executions:** The remaining quantity of the aggressing order will execute against the hidden sizes of B1 and B2 in a pro-rated fashion.  
Trade 3: B1 executes hidden qty of 200 with S1 @ 10. The display qty for B1 will be 0 and the remaining qty 200.  
Trade 4: B2 executes hidden qty of 300 with S1 @ 10. The display qty for B2 will be 0 and the remaining qty 300.

B1 and B2 will then replenish based on the Random Replenishment %.

## 19 APPENDIX J – SELF-MATCH PREVENTION WORKED EXAMPLES

### 19.1.1 Submission of an Order with a Unique Key via FIX / Native Trading Gateway Resulting in Self-Match Prevention

Main Order Book							
Order ID	Unique Key	CompID	Bid Size	Bid Price	Offer Price	Offer Size	Order ID
B1	CL1	CompID1	200	85210			
B2	CL2	CompID2	100	85210			

A Trader via CompID1 submits a sell limit order S1 of 300 quantity at price 85210 with a unique key of CL2 via the FIX Trading Gateway.

The following trade will be executed:

Trade	Buy Order	Sell Order	Exec Qty	Exec Price
T1	B1	S1	200	85210

Order B2 will be expired due to Self-Match Prevention.  
The remainder of the S1 order of 100 qty will be added to the order book.

### 19.1.2 Self-Match Prevention Functionality in Relation to Circuit Breakers

#### The Impact of Self-match Prevention during Circuit Breaker Triggers

The trading parameters set as follows:

<b>CB Trigger Policy</b>	Pre-Execution
<b>CB Trigger Session</b>	Volatility Auction Call
<b>CB Remainder Policy</b>	Add to Book
<b>Static CB Percentage (%)</b>	5.00

The instrument ANH is in a Continuous Trading session and the order book is as follows:

**Main Order Book**

**Lower CB = 80892.50 | SRP = 85150.00 | Upper CB = 89407.50**

Order	Unique Key	CompID	Qty	Price	Price	Qty	CompID	Unique Key	Order
B2	CL7	CompID 1	250	89390	89408	100	CompID 4	CL1	S1
B3	CL9	CompID 2	100	89390	89409	250	CompID 2	CL6	S2
B1	CL3	CompID 3	150	89385	89410	200	CompID 2	CL8	S3

A Trader via CompID4 submits a buy limit order B4 of qty 400 at price 89410 with a unique key of CL1 via the Native Trading Gateway:

Symbol	OrderID	Owner	Side	OrdType	TIF	Price	OrderQty	Self Trade Prevention Key
ANH	B4	CompID2	Buy	Limit	DAY	89410	400	CL1

The circuit breaker will trigger as the potential execution between B4 and S1 at 89408 will breach upper circuit breaker limit (circuit breaker limit validation is evaluated before self-match prevention validation).

The order book will move to a Volatility Auction Call as follows:

Order	Unique Key	CompID	Size	Price	Price	Size	CompID	Unique Key	Order
B4	CL1	CompID4	400	89410	89408	100	CompID4	CL1	S1
B2	CL7	CompID1	250	89390	89409	250	CompID2	CL6	S2
B3	CL9	CompID2	100	89390	89410	200	CompID2	CL8	S3
B1	CL3	CompID3	150	89385					

Once the volatility auction uncrosses without any changes to the order book, the following executions will occur:

Trade	Buy Order	Buy Key	Sell Order	Sell Key	Exec Qty	Exec Price	Comments
T1	B4	CL1	S1	CL1	89410	100	This is a self-match scenario. However, since this is executed during an auction, self-match prevention will not be enforced.
T2	B4	CL1	S2	CL6	89410	250	Not a self-match.
T3	B4	CL1	S3	CL8	89410	50	Not a self-match.

The final order book at Continuous Trading will be as follows:

Lower CB = 80892.50   SRP = 85150.00   Upper CB = 89407.50									
Order	Unique Key	Compl D	Qty	Price	Price	Qty	Compl D	Unique Key	Order
B2	CL7	Compl D1	250	89390	89410	150	Compl D2	CL8	S3
B3	CL9	Compl D2	100	89390					
B1	CL3	Compl D3	150	89385					

### 19.1.3 Self-Match Prevention Functionality in Relation to Fill or Kill (FOK) Orders

#### The Behaviour of FOK Orders during Self-Match Prevention when the Order Can be Filled

The instrument ANH is in a Continuous Trading session and the order book is as follows:

Main Order Book									
Order	Unique Key	ComplID	Qty	Price	Price	Qty	ComplID	Unique Key	Order
B1	CL1	ComplID2	500	89010	89011	200	ComplID4	CL3	S1
B2	CL2	ComplID2	1500	89010	89011	300	ComplID4	CL4	S2
B3	CL5	ComplID4	500	89010					

A Trader via CompID2 submits a sell limit order S3 of qty 2000 at price 89010 with a unique key of CL1 via the FIX Trading Gateway:

Symbol	OrderID	Owner	Side	OrdType	TIF	Price	OrderQty	NoTradeKey
ANH	S3	Comp2	Sell	Limit	FOK	89010	2000	CL1

The following trades will occur:

Trade	Buy Order	Sell Order	Exec Qty	Exec Price
T1	B2	S3	1500	89010
T2	B3	S3	500	89010

Order B1 will be expired due to self-match prevention.

**Note:** The system checks the FOK orders in two loops.

1. In the first loop, the system will check whether the FOK quantity can be fulfilled from the non-self-matching orders.
2. Upon the identification of the FOK quantity from the non-self-matching orders, the system will execute the SMP checks during the second loop. The SMP functionality will not be triggered if FOK quantity is not satisfied from the non-self-matching orders.

The final order book will be as follows:

Order	Unique Key	CompID	Qty	Price	Price	Qty	CompID	Unique Key	Order
					89011	200	Comp4	CL3	S1
					89011	300	Comp4	CL4	S2

### The Behaviour of FOK Orders during Self-Match Prevention when the Order Cannot be Filled

The instrument ANH is in a Continuous Trading session and the order book is as follows:

Main Order Book									
Order	Unique Key	CompID	Qty	Price	Price	Qty	CompID	Unique Key	Order
B1	CL1	Comp4	1000	89011	89012	500	Comp2	CL3	S1
B2	CL2	Comp4	750	89011	89012	1000	Comp2	CL4	S2

A Trader via CompID2 submits a buy limit order B3 of qty 1400 at price 89013 with a unique key CL3 via the FIX Trading Gateway:

Symbol	OrderID	Owner	Side	OrdType	TIF	Price	OrderQty	NoTradeKey
ANH	B3	CompID2	Buy	Limit	FOK	89013	1400	CL3

No trades will be executed because the FOK quantity of 1400 cannot be filled with the non-self matching passive orders.

The aggressing FOK order B3 will be expired due to the unfilled quantity with the "Expired (unfilled FOK order)" reason.

**Note:** The system checks the FOK orders in two loops.

1. In the first loop, the system will check whether the FOK quantity can be fulfilled from the non-self-matching orders.
2. Upon the identification of the FOK quantity from the non-self-matching orders, the system will execute the SMP checks during the second loop. The SMP functionality will not be triggered if FOK quantity is not satisfied from the non-self-matching orders.

The final order book will be as follows:

Order	Unique Key	CompID	Qty	Price	Price	Qty	CompID	Unique Key	Order
B1	CL1	Comp4	1000	89011	89012	500	Comp2	CL3	S1
B2	CL2	Comp4	750	89011	89012	1000	Comp2	CL4	S2

#### 19.1.4 Example: Self-Match Prevention Functionality in Relation to Closing Price Cross (CPX) Orders

##### The Behaviour of CPX Orders during Self-Match Prevention

Provided the Equity instrument is in Continuous Trading and the order book is as follows:

Main Order Book									
Order	Unique Key	CompID	Qty	Price	Price	Qty	CompID	Unique Key	Order
B1	HL2	CompID2	350	85170	85173	300	CompID2	<None>	S1
B2	HL2	CompID2	200	85165	85174	100	CompID4	HL5	S2



The following CPX orders are parked in the queue:

Order	Unique Key	CompID	Qty	Price	Entry Time	Price	Qty	CompID	Unique Key	Order	Entry Time
B4	HL6	CompID2	350	85170	10.12	85165	500	CompID2	HL2	S3	10.13

When the closing price is generated at 85170 after the closing auction uncross, the session is moved to the Closing Price Publication and then to Closing Price Cross Session.

B4 will be added to the order book, then the limit price of S3 will be repriced to 85170 and added to the order book.

B1 will be expired due to Self-Match Prevention.

The following trades will be executed:

Trade	Buy Order	Sell Order	Exec Qty	Exec Price
T1	B4	S3	350	85170

The order book at the end of the Closing Price Cross session will be as follows:

Order	Unique Key	CompID	Size	Price	Price	Size	CompID	Unique Key	Order
B2	HL2	CompID2	200	85165	85170	150	CompID2	HL2	S3
					85173	300	CompID2	<None>	S1
					85174	85174	85174	85174	85174

## 19.1.5 Example: Self-Match Prevention Functionality in Relation to Iceberg Orders

### The Behaviour of Iceberg Orders during Self-Match Prevention

Given the Equity instrument is in Continuous Trading and the order book is as follows:

Main Order Book									
Order	Unique Key	Comp ID	Qty	Price	Price	Qty	CompID	Unique Key	Order
					85600	300	CompID1	CL7	S4
					85650	200 (200) *	CompID1	CL2	S1
					85650	100 (400) *	CompID2	CL3	S2
					85650	250	CompID2	CL9	S3

\* Notation relates to Visible qty (Hidden qty)

A Trader submits via CompID1 a buy market order B1 of qty 1000 with a unique key of CL3, via the Native Trading Gateway;

The following trades will be executed:

Trade	Buy Order	Sell Order	Exec Qty	Exec Price
T11	B1	S4	300	85600
T12	B1	S1	200	85650
T13	B1	S3	250	85650
T14	B1	S1	200	85650

S2 will be expired due to Self-Match Prevention.

The unexecuted 50 quantity of B1 will be expired.